

REV	ZONE	REVISION	DATE	ECN	NAME	CHKD
B-1	ALL	RELEASE TO PRODUCTION	2/11/16	PKC0099	GES	AEK

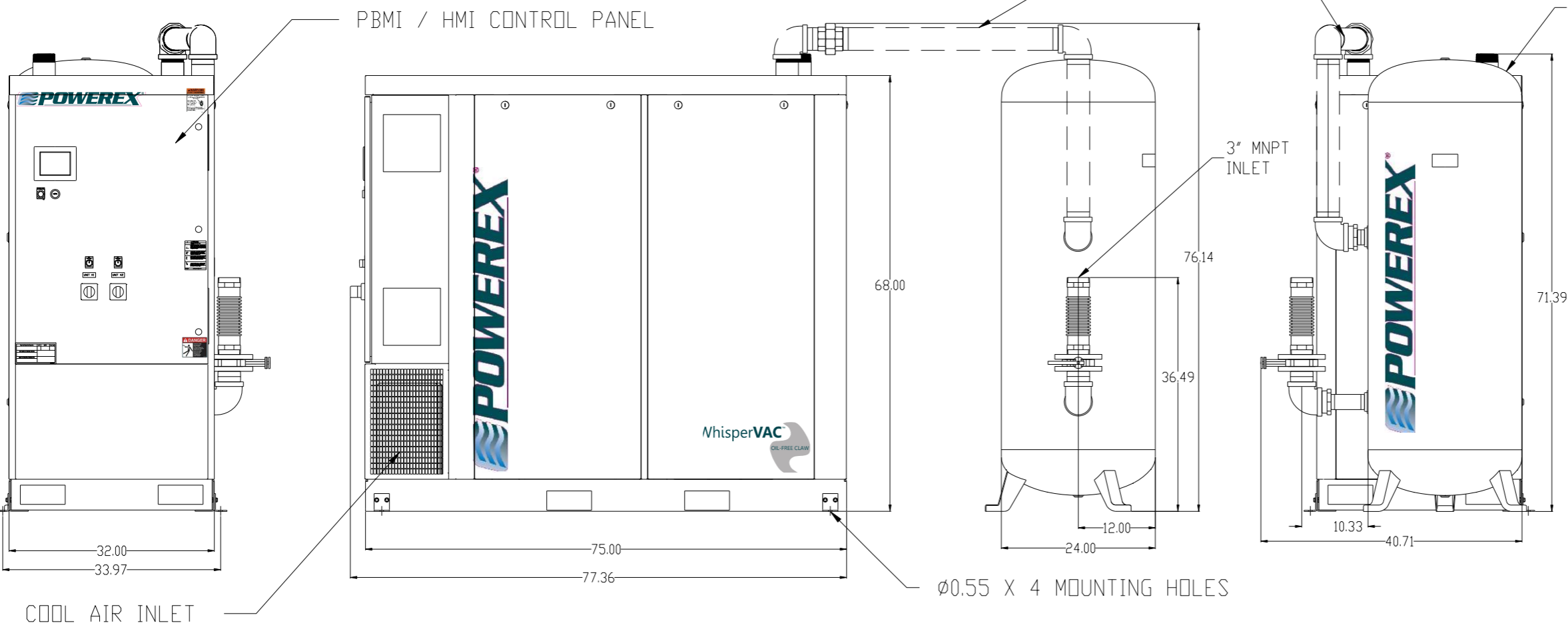
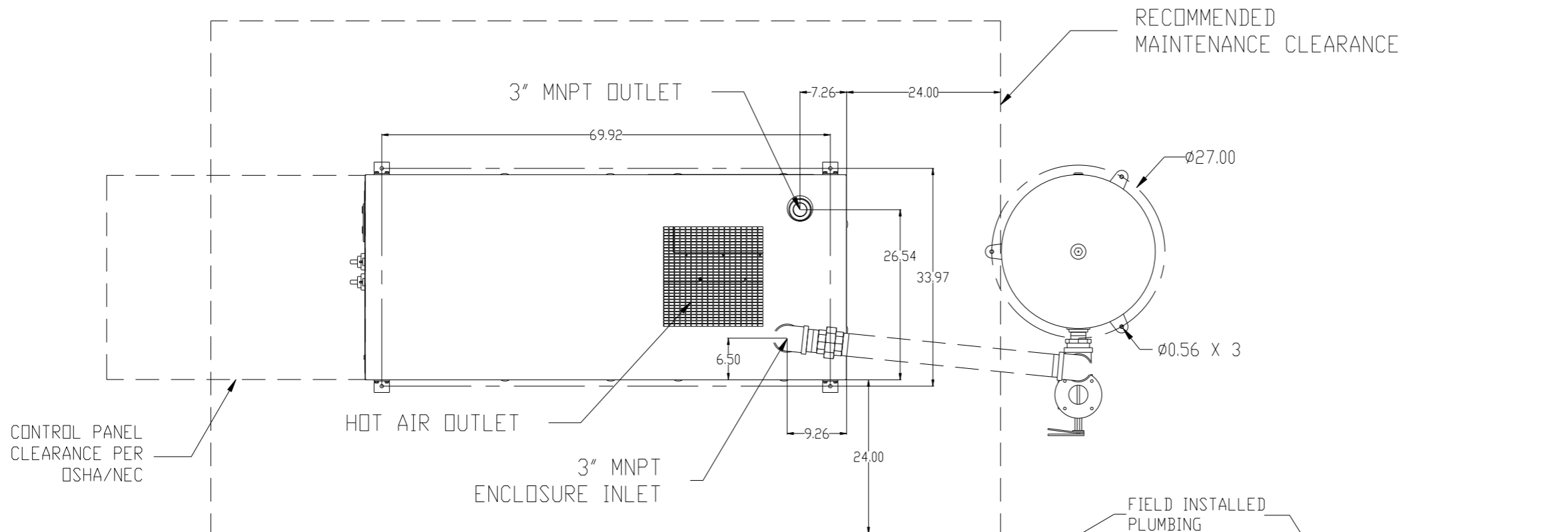

NOTES:
 1.) SHEET 1, UNIT BUILD
 2.) SHEET 2, FLOW SCHEMATIC

SYMBOL LEGEND ⊖ = MINUS DRAFT ⊕ = PLUS DRAFT TOLERANCES NOT SPECIFIED .XX ± .XXX ± \angle (DEG) ±		⊕ = ADDITIONAL CONTROL REQ'D HRC = BRINELL HARDNESS Drawings to conform to the current revision of the following ANSI standards: Y14.3 Multi and sectional view dsgs. Y14.5M Dimensioning and tolerancing	
AUTOCAD REL2014LT INCH		DO NOT SCALE DRAWING FOR DIMENSIONS Sheet 1 of 2 SCALE 1:10	
CONFIDENTIAL DISCLOSURE This drawing is the property of POWEREX INC. of the SCOTT FETZER COMPANY and subject to return on demand. Its contents are confidential and must not be copied or submitted to outside parties for use or examination.		DRAWN BY: GES CHECKED BY: AEK 2/11/16	
MATERIAL: N/A PART NAME: LAB CLAW ENCLOSED 7.5HP DUPLX VAC 120G		APPROVED BY: ENGINEERING MFG/MKTG GES RJR 2/11/16 2/11/16 2/11/16 2/11/16	
DWG NO: LCED0754		SIZE: D 150 PRODUCTION DRIVE, HARRISON, OHIO 45030 Ph 888-769-7979 FAX (513) 367-3125	

REV	ZONE	REVISION	DATE	ECN	NAME	CHKD
B-1	ALL	RELEASE TO PRODUCTION	2/11/16	PKC0099	GES	AEK

SOURCE VALVE
(SEE NOTE 2)

FIELD SUPPLIED PIPING FROM
ENCLOSURE TO TANK

3" MNPT OUTLET
AIR CONNECTION

FLEX JOINT 3"

OUTLET SILENCER

3" MNPT INLET
AIR CONNECTION
-TO VACUUM RECEIVER-

CONTROL WIRES
TO PANEL

INTERNALLY
LINED
VACUUM
TANK

FLEX JOINT 3"

ISOLAT.
VALVE

SIGHT
GAUGE

1/4" DRAIN
VALVE

CONTROL PANEL

ADD.
HANG TAG
IP638500AV

ISOLAT.
VALVE

AIR
FILTER

CV

VAC.
PUMP
#2

TSH
2

ISOLAT.
VALVE

AIR
FILTER

CV

VAC.
PUMP
#1

TSH
1







1/4" DRIP LEG

1/4" DRIP LEG

VACUUM UNIT ENCLOSURE

NOTE:
A 1/4 INCH VENT PLUG IS
LOCATED IN EACH FILTER HOUSING.

LEGEND

	TEMP. SWITCH		VACUUM TRANSDUCER
	AIR FILTER		CHECK VALVE
	BALL VALVE		FLEX LINE
			UNION

NOTES:
1) TSH - TEMPERATURE SWITCH HIGH
2) IF THE SYSTEM REQUIRES A NFPA SOURCE VALVE, IT IS SUPPLIED BY OTHERS.
3) OUTLET SILENCER AND FLEX LINES SHIP LOOSE FOR FIELD INSTALLATION.

SYMBOL LEGEND ⊖ = MINUS DRAFT ⊕ = PLUS DRAFT TOLERANCES NOT SPECIFIED .XX ± .XXX ± \angle(DEG) ±		ADDITIONAL CONTROL REQ'D BRINELL HARDNESS	Drawings to conform to the current revision of the following ANSI standards: Y14.3 Multi and sectional view dgs. Y14.5M Dimensioning and tolerancing
AUTOCAD REL2014LT INCH		DO NOT SCALE DRAWING FOR DIMENSIONS Sheet 2 of 2 SCALE 1:10	
CONFIDENTIAL DISCLOSURE This drawing is the property of POWEREX INC. of the SCOTT FETZER COMPANY and subject to return on demand. Its contents are confidential and must not be copied or submitted to outside parties for use or examination.			
DRAWN BY GES	CHECKED BY AEK	APPROVED BY ENGINEERING GES	MFG/MKTG RJR
2/11/16	2/11/16	2/11/16	2/11/16
MATERIAL N/A		 150 PRODUCTION DRIVE, HARRISON, OHIO 45030 Ph 888-769-7979 FAX (513) 367-3125	
PART NAME LAB CLAW ENCLOSED		DWG NO LCED0754	SIZE D
7.5HP DUPLX VAC 120G		iced0754.dwg	