

FirstCall[™] Medical Gas Alarm Operating & Maintenance Manual

Please read and save these instructions. Read carefully before attempting to assemble, install, operate or maintain the product described. Protect yourself and others by observing all safety information. Failure to comply with instructions could result in personal injury and/or property damage! Retain instructions for future reference.

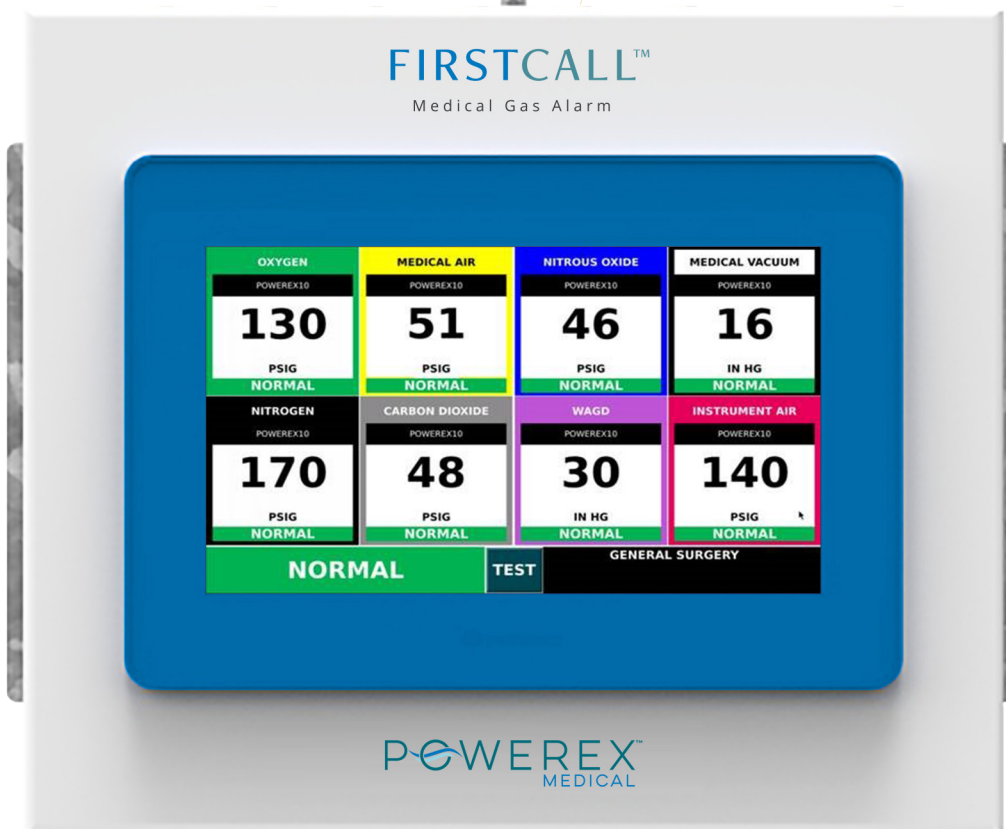

Table of Contents

Responsibilities	4	Basic Settings	22
Introduction	4	Alarm Messages	22
Safety Guidelines	4	Alarm History	22
Product Line Overview	4	Alarm Status	22
Configuration of Models	5	Alarm Summary	23
Area Alarm	5	Gas Settings	23
Master Alarm	5	Master Alarm Settings	24
Combo Alarm	5	Source Gas Description	24
Installation	6	Dry Contact Settings	25
Unpacking Guide	6	Maintenance Mode	25
Rough-in Install	6	Change Password	25
Wiring for Power	7	Screen Saver & Brightness Settings	25
Sensor Installation	7	Transducer Settings	26
Low Voltage Wiring	8	Test & Set High/Low Alarm Points	
Front Panel Assembly	8	+/- 20% Current Pressure	26
Wiring Schematics	10	BACNet Settings	26
1-4 Gas Area Alarm Panels	10	Operation	27
5-8 Gas Area Alarm Panels	11	TEST Feature	27
23 Digital Input Master Alarm Panel	12	Master Alarm Inputs	27
39 Digital Input Master Alarm Panel	13	Alarm Event	27
55 Digital Input Master Alarm Panel	14	Silencing the Alarm	27
23 Digital Inputs and 1-4 Gas		Maintenance	29
Combo Alarm Panels	15	Cleaning	29
23 Digital Inputs and 5-6 Gas		Battery	29
Combo Alarm Panels	16	Maintenance Mode	29
39 Digital Inputs and 1-4 Gas		Parts Maintenance List	30
Combo Alarm Panels	17	Troubleshooting Guide	31
39 Digital Inputs and 5-6 Gas		Specifications	32
Combo Alarm Panels	18	Appendix A. BACnet Object Names	33
55 Digital Inputs and 1-4 Gas		Warranty	35
Combo Alarm Panels	19		
55 Digital Inputs and 5-6 Gas			
Combo Alarm Panels	20		
Setup and Configuration	21		
Login to Settings	21		
Keyboard Basics	21		
Zone Served Block	21		
Gas Badges	21		
Settings Menu	22		

Responsibilities

Information contained in this manual pertains to the Powerex FirstCall™ medical gas alarm system. The alarm system will operate as described in this manual when operated and serviced in compliance with the instructions.

Installer Responsibilities

The alarm should be handled, installed, and tested per the recommended practice as described within this manual. Should any repair or replacement become necessary, contact Powerex for original equipment or replacement parts.

User Responsibilities

The alarm should be tested and examined periodically according to facility codes. Any parts which are found to be damaged, corroded, contaminated, etc. should be replaced.

Introduction

Safety Guidelines

Installation of the Powerex FirstCall™ alarm involves installing the rough-in box, the risers & the transducers (if it is an area alarm or combination alarm) and front panel and making the necessary conduit, plumbing and electrical connections. All installation and testing should be done in accordance with NFPA 99.

⚠ WARNING Electrical power intended for the alarm to be installed should be disconnected prior to installation. *Attention: l'alimentation électrique a l'intention de faire installer l'alarme devrait déconnecter avant l'installation.*

⚠ WARNING This device should only be installed by qualified personnel. Installation should not be attempted by anyone not having general experience with the installation of devices of this nature. *Attention: cet appareil ne devrait installer que le personnel qualifié. L'installation ne devrait pas tenter par une personne n'ayant pas d'expérience générale avec l'installation d'appareils de cette nature.*

Product Line Overview

The Powerex FirstCall™ medical gas alarm systems monitor the status of medical gases in Category 1 healthcare facilities. The alarm systems are ETL listed to UL 1069 and comply with the latest edition of NFPA 99.

All alarm systems provide audible and visible indications of NFPA 99 medical gas alarm conditions.

The FirstCall™ Master Alarm system monitors up to 56 signals indicating the operation and condition of the source of supply, the reserve source (if any), and the pressure in the main lines of each medical gas and vacuum piping system in a Category 1 healthcare facility.

The FirstCall™ Area Alarm system monitors the pressure of up to 8 medical gases supplying anesthetizing locations and other Category 1 spaces.

The FirstCall™ Combination Alarm system monitors up to 56 source signals (Master) and up to 6 medical gases (Area) in a single panel.

Powerex FirstCall™ Features and Benefits include:

- Designed and manufactured in the USA
- 5 year warranty on parts, 2 year warranty on labor
- 10" high-resolution touchscreen HMI with 7" VE option available
- Area alarm up to 8 gases
- 4-20mA signal transducers, DISS demand-check fittings, and gas risers included with Area Alarm
- Transducers are able to be remotely installed up to 5,000 ft away
- Master alarm 23, 39, and 55 input signals
- Combination alarm up to 6 gases, 23, 39, or 55 input signals
- Ethernet connectivity using BACnet over IP protocol to building management system - standard
- Customizable emergency instructions in the event of an alarm
- Easy to use interface for setup and changing settings
- Pre-programmed NFPA 99 gas labels and colors
- Event history log accessible at the screen
- Alarm test feature – able to use quickly without logging in
- Area alarm automatically sets NFPA 99 +/-20% limits based on current pressure
- Master alarm pre-programmed NFPA 99 source alarm signals – also customizable

- Master alarm signals organized under main source badge – click through for individual alarm information
- Push-in terminal blocks to easily connect transducer and source equipment alarm signals
- Factory set for normally closed signals, able to change to normally open
- Transducers are gas-specific, and cross-connecting a transducer with an assigned gas input will generate an alarm per 2018 NFPA 99
- Hinged frame for easy assembly and maintenance
- Option for digital outputs – contact factory

PLC + HMI

Combination PLC+HMI monitors inputs from medical gas transducers and alarm points. Input status displayed on high quality LED HMI touchscreens with compact built in PLC. Preprogrammed standard settings included with all medical gas inputs. Alarm set points, alarm messages and descriptions of sources are fully customizable. Alarm and error history is recorded in Alarm Summary.

The unit is capable of communicating with building monitoring system via Ethernet connection using BACnet over IP.

Screen sizes include 7" and 10". Both are LED HMI touchscreens.

7"

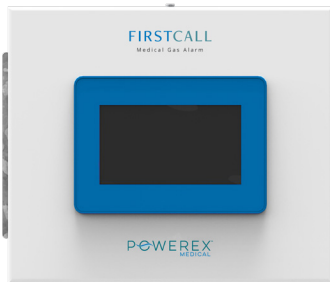

10.1"



Configuration of Models

Area Alarm

AAP7-X thru AAP7-XXXXXXXX (7" panel)

AAP10-X thru AAP10-XXXXXXXX (10" panel)

X = gas up to 8

O = Oxygen

A = Medical Air

V = Vacuum

2 = N2O

N = N2

C = CO2

W = WAGD

I = Instrument Air

Example: AAP10-OAV Area Alarm 10" screen Oxygen, Air, Vacuum

Master Alarm

MAP7-YY

MAP10-YY

YY = digital inputs (23, 39, or 55)

Example: MAP7-23 Master Alarm 7" screen 23 input signals

Combination Alarm

CAP7-X-YY thru CAP7-XXXXXX-YY (7" panel)

CAP10-X-YY thru CAP10-XXXXXX-YY (10" panel)

X = gas up to 6

O = Oxygen

A = Medical Air

V = Vacuum

2 = N2O

N = N2

C = CO2

W = WAGD

I = Instrument Air

YY = digital inputs (23, 39, or 55)

Example: CAP10-OAV2CW-55 Combo Alarm 10" screen Oxygen, Air, Vacuum, N2O, CO2, WAGD, 55 input signals

Installation

Unpacking Guide

Rough-in box electrical component guide

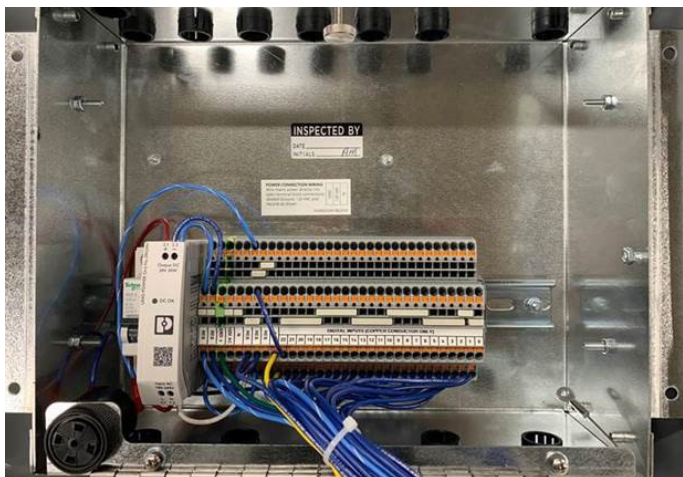

Rough-in box contains power supply, circuit breaker, terminal blocks, input expansions and holes for main line power connection and riser connections.

Cover with PLC+HMI



PLC+HMI is attached to cover and shipped unattached from the rough-in box. Cover should only be attached after wall construction is complete.

Riser Guide (Area & Combo Alarm only)



Risers are type L copper tubing with lead free brass fitting. Risers require gas specific DISS fitting with demand valve to be installed prior to installing transducers. Risers are included standard with all area and combination alarm panels.

Transducer Guide (Area & Combo Alarm only)



Transducers are unique to each gas. Each transducer is labeled appropriate gas and has the corresponding DISS hex nut attached to the sensing end. Transducers have a solid brass body with 1/2" NPS threads on cord end for easy remote installation.

Medical Gas	Part Number
Oxygen	TDCR-O2
Medical Air	TDCR-AIR
Medical Vacuum	TDCR-VAC
Nitrous Oxide	TDCR-N2O
Nitrogen	TDCR-N2
Carbon Dioxide	TDCR-CO2
WAGD	TDCR-WAGD
Instrument Air	TDCR-INST

Rough-in Install

Rough-in box is shipped with dust cover installed. Dust cover will need to be removed to install the rough-in box and make electrical connections. The dust cover should re-installed after the main line electrical connection is fully connected to protect the electrical components until the wall covering is complete.

Adjustable depth mounting flanges (right & left) should be utilized to align the front edge of the rough-in box to be flush with the drywall surface.

Fasten the box to vertical supports (wall studs) so that the center of the alarm panel is at appropriate use height. **NOTE:** Rough-in box should be installed with open side facing the outside of the wall and the hinge attachment point at the bottom of the panel.

Reinstall cardboard dust cover.

Wiring for Power

⚠ CAUTION For personal safety, lock out and tag out the associated circuit breaker disconnect for the source of 120V AC power. *Attention: Pour votre sécurité personnelle, verrouillez et étiquetez le sectionneur du disjoncteur associé pour la source d'alimentation de 120 V CA.*

⚠ CAUTION For personal safety and to avoid damage to the alarm, ensure that the circuit breaker is in the OFF position. *Attention: Pour votre sécurité personnelle et pour éviter d'endommager l'alarme, assurez-vous que le disjoncteur est en position OFF.*

Route incoming mains power through the knock-out at the bottom of the rough-in box with a UL recognized cable with a minimum gauge of 18 AWG and rated for 100-240V AC, 50/60Hz, 2A, single phase power.

All Models of Powerex FirstCall alarm Panels must be powered by the life safety branch or critical branch of the essential electrical system as required in NFPA 99.



Ground wire – Strip ½” of insulation and connect the ground wire to the appropriate terminal block (GND).

Neutral wire – Strip ½” of insulation and connect the neutral lead to the appropriate terminal block (N).

Hot wire – Strip the insulation and connect the hot lead to the appropriate terminal block (120V AC).

Sensor Installation (Area & Combo Alarms Only)

Local Installation

Locate copper risers packaged inside the alarm rough-in box.

Install the risers into the top of the rough-in box through the holes provided using NPS threads on brass fitting and washer. **NOTE:** All access holes in the rough-in box are plugged with plastic snap in caps.

Braze copper tubes to appropriate building plumbing using appropriate NFPA 99 procedures. Install the gas specific DISS demand valve into the appropriate riser.

Pipeline Remote Installation

Sensors may be installed directly onto hospital pipeline by placing transducer in junction box and attaching appropriate gas.

ZVB Remote Installation

Sensors may be installed remotely in Powerex zone valve boxes using appropriate Powerex zone valve box sensing kit.

Part Number	Description
SENSE-O2	Oxygen Sensing Kit
SENSE-AIR	Medical Air Sensing Kit
SENSE-VAC	Medical Vacuum Sensing Kit
SENSE-N2O	Nitrous Oxide Sensing Kit
SENSE-N2	Nitrogen Sensing Kit
SENSE-CO2	Carbon Dioxide Sensing Kit
SENSE-WAGD	WAGD Sensing Kit
SENSE-INST	Instrument Air Sensing Kit

Remove the plug from the top port on the appropriate valve in the zone valve box. Install ⅛” to ¼” reducer elbow into the port.

Install the ¼” to DISS adapter with demand valve into the reducer elbow.

Attach the transducer to the DISS fitting.

Low Voltage Wiring

Wire Type and Size

All low voltage wiring must meet the following requirements:

- Stranded wire no smaller than 22 AWG, conductor insulation at least .010in.
- Circuit length not to exceed the following lengths for the indicated wiring gauges:
 - Up to 5000 feet: 18 AWG
 - Up to 3200 feet: 20 AWG
 - Up to 2000 feet: 22 AWG
- Cable must be twisted pair shielded type. Multi-pair cables within one common shield are acceptable.

Sensor wiring (Area & Combo Alarm only)

CAUTION For personal safety, lock out and tag out the associated circuit breaker disconnect for the source of 120V AC power. *Attention: Pour votre sécurité personnelle, verrouillez et étiquetez le sectionneur du disjoncteur associé pour la source d'alimentation de 120 V CA.*

CAUTION For personal safety and to avoid damage to the alarm, ensure that the circuit breaker is in the OFF position. *Attention: Pour votre sécurité personnelle et pour éviter d'endommager l'alarme, assurez-vous que le disjoncteur est en position OFF.*

Install the sensor wires into the appropriate terminal block. There are enough terminal blocks for up to 8 gases. Install the sensors in the order they are to be displayed on the screen.

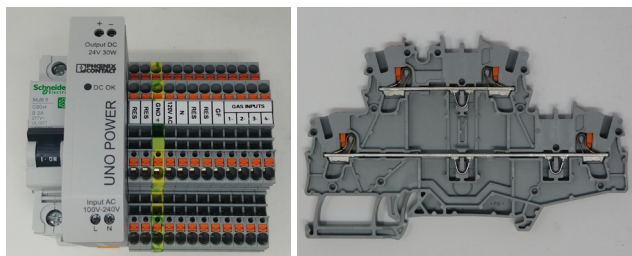

The terminal blocks are push-in style with a release button. A small flat-head screwdriver (or similar tool) should be used to depress the release button to make wire insertion easier.

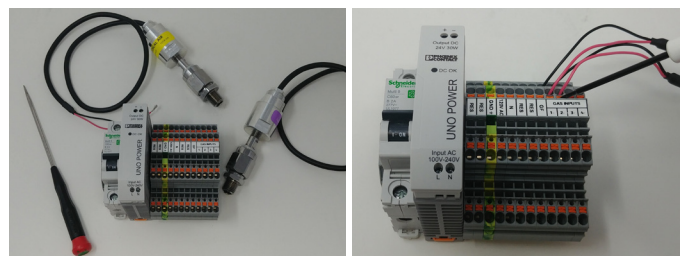
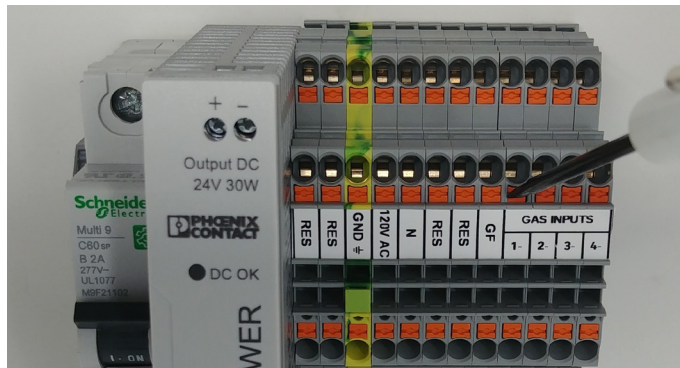

It is important that the sensors are wired to the correct terminal block. Per NFPA 99, an alarm will sound for cross-connected sensors.

Source alarm signal wiring (Master & Combo Alarm only)

Install the input wires from the source equipment into the appropriate terminal blocks.

Front Panel Assembly

Front cover assembly with HMI+PLC combination screen is shipped unattached to the rough-in box assembly. Front cover is attached using hinge on lower inside flange of rough-in box.



Remove dust cover from rough-in box and discard.

Attach front cover by placing threaded studs on lower flange of cover through the provided hinge holes. Place provided hex nuts over studs and tighten.

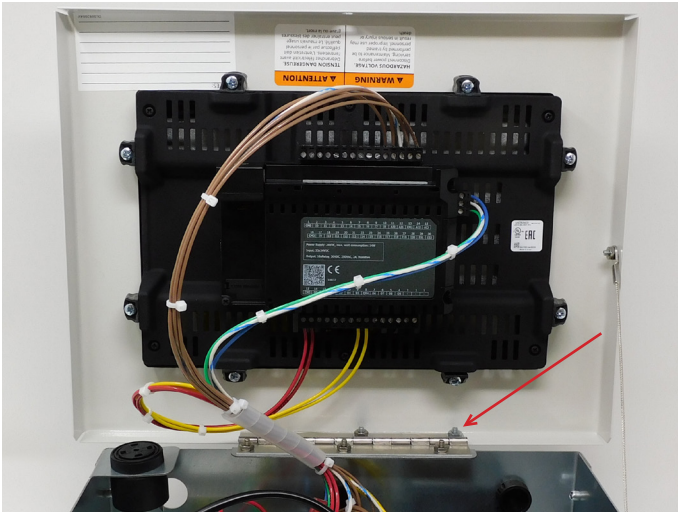

Place unattached side of panel lanyards over provided threaded studs on the left side of the cover assembly. Place provided washer and hex nut over the stud and tighten the hex nuts.



Plug wired connectors from terminal blocks into appropriate input blocks in PLC.

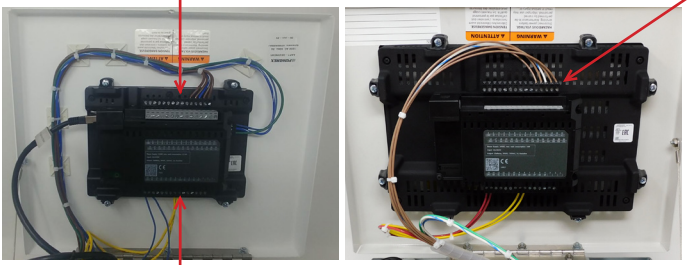

Plug power cord from power supply into power slot on PLC.

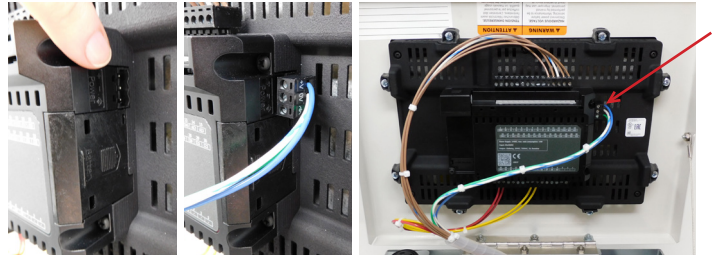

(For panels with 39+ digital inputs and/or 5+ gas inputs) Plug I/O module expansion adapter cord into appropriate port.

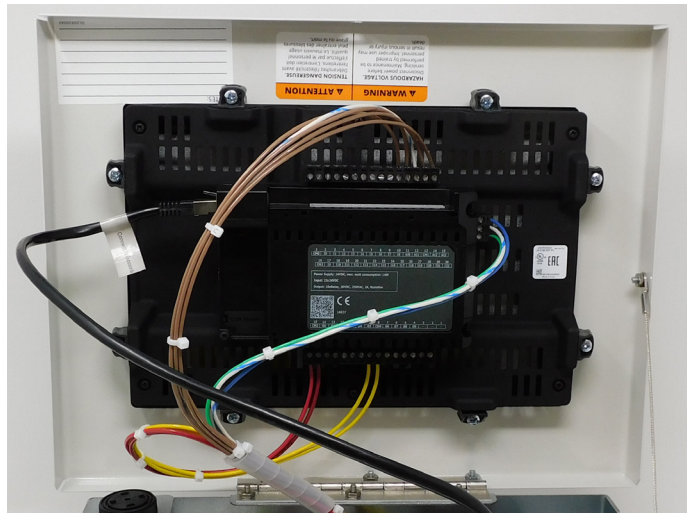

Wiring Diagram Guide

The terminal blocks in the Powerex FirstCall™ Alarm panels have two tiers, each of which contains an independent circuit.

The image below shows a sample terminal block layout from the alarm panel with the top and bottom circuits labeled and correspond with the labeled circuits on the sample wiring diagram above.

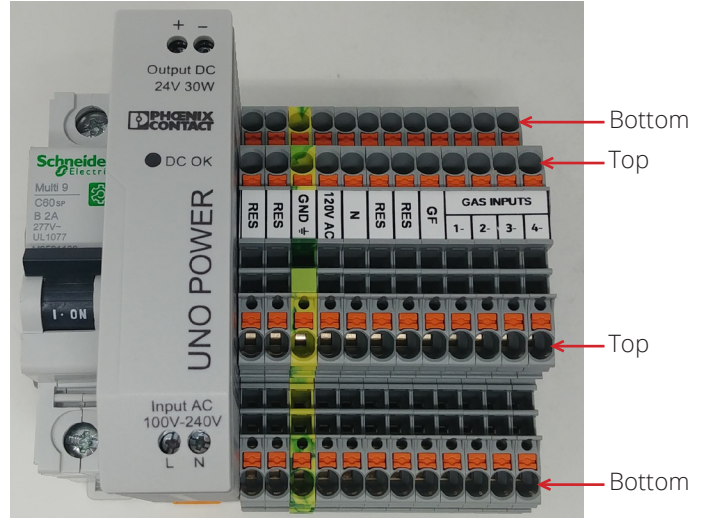
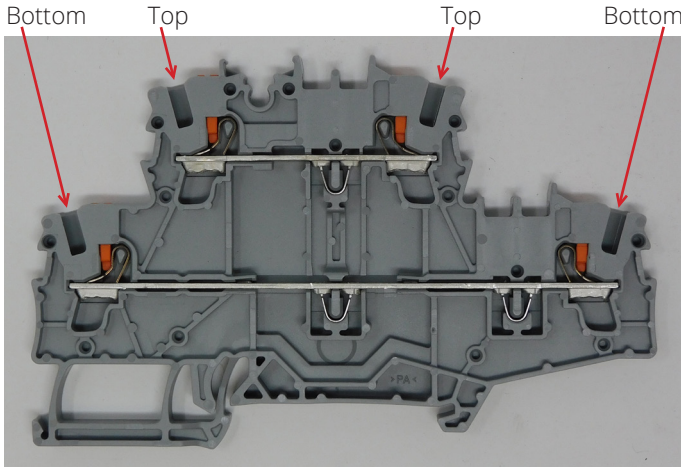

The wiring diagrams on the following pages show this separation of circuits by separating the top and bottom circuits as two separate rows labeled with a legend that applies to both the top and bottom circuits.

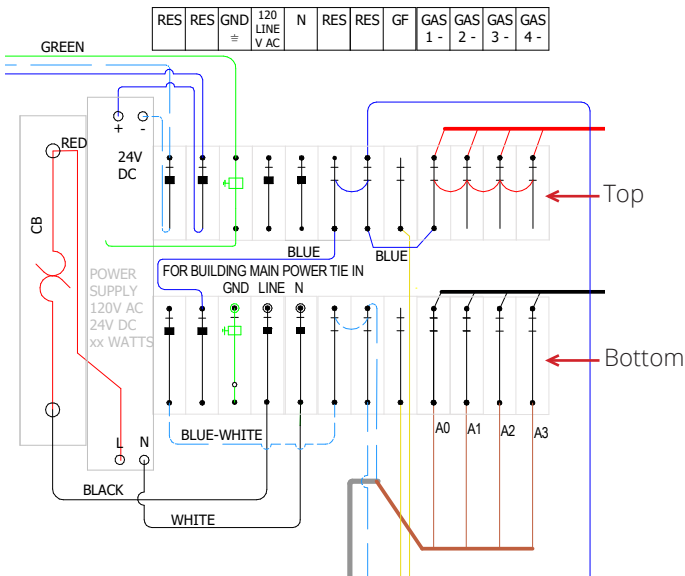

Area Alarm Panel Wiring Schematic

1-4 Gas Area Alarm Panels – AP000A004AJ

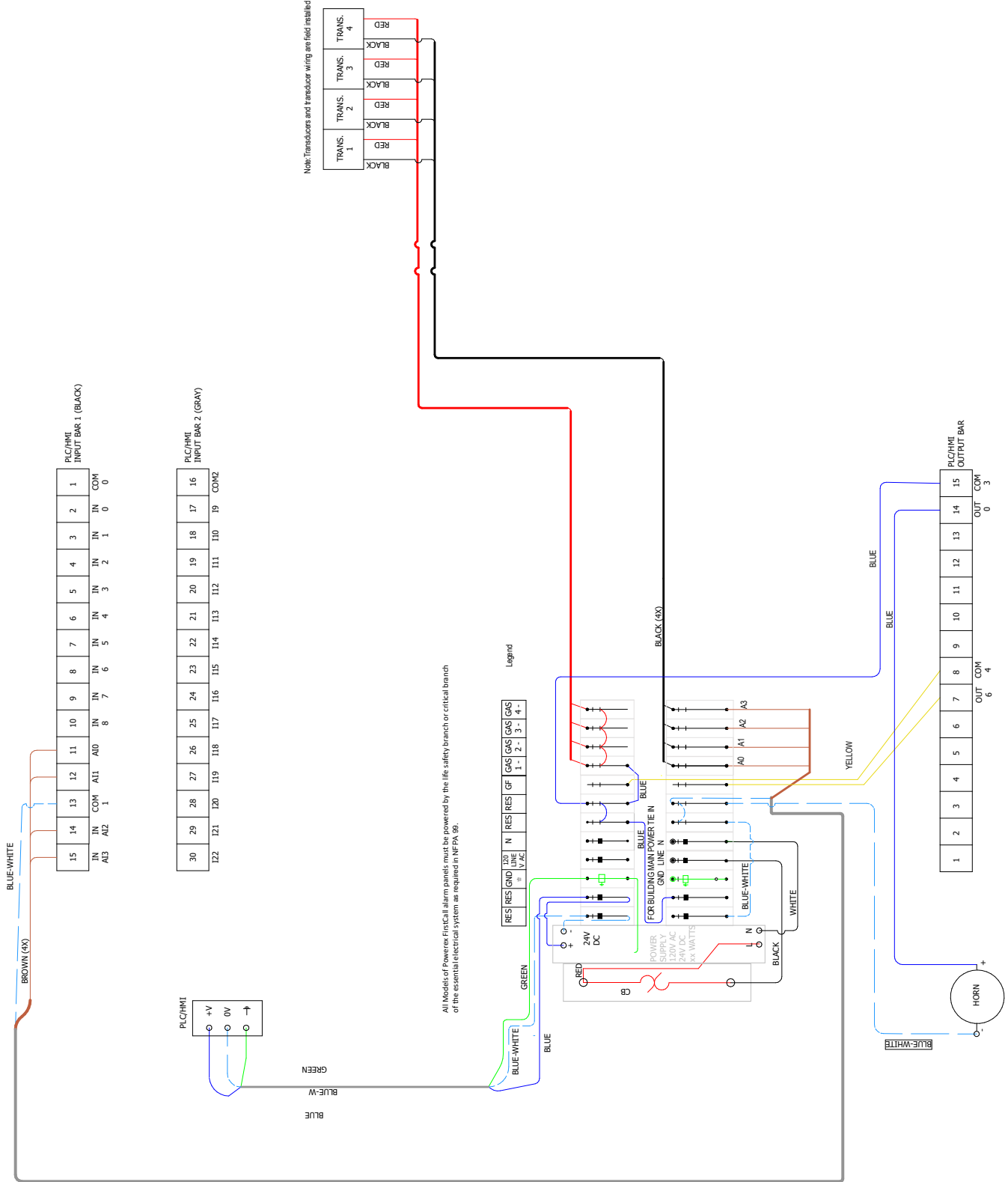

Area Alarm Panel Wiring Schematic

5-8 Gas Area Alarm Panels – AP000A008AJ

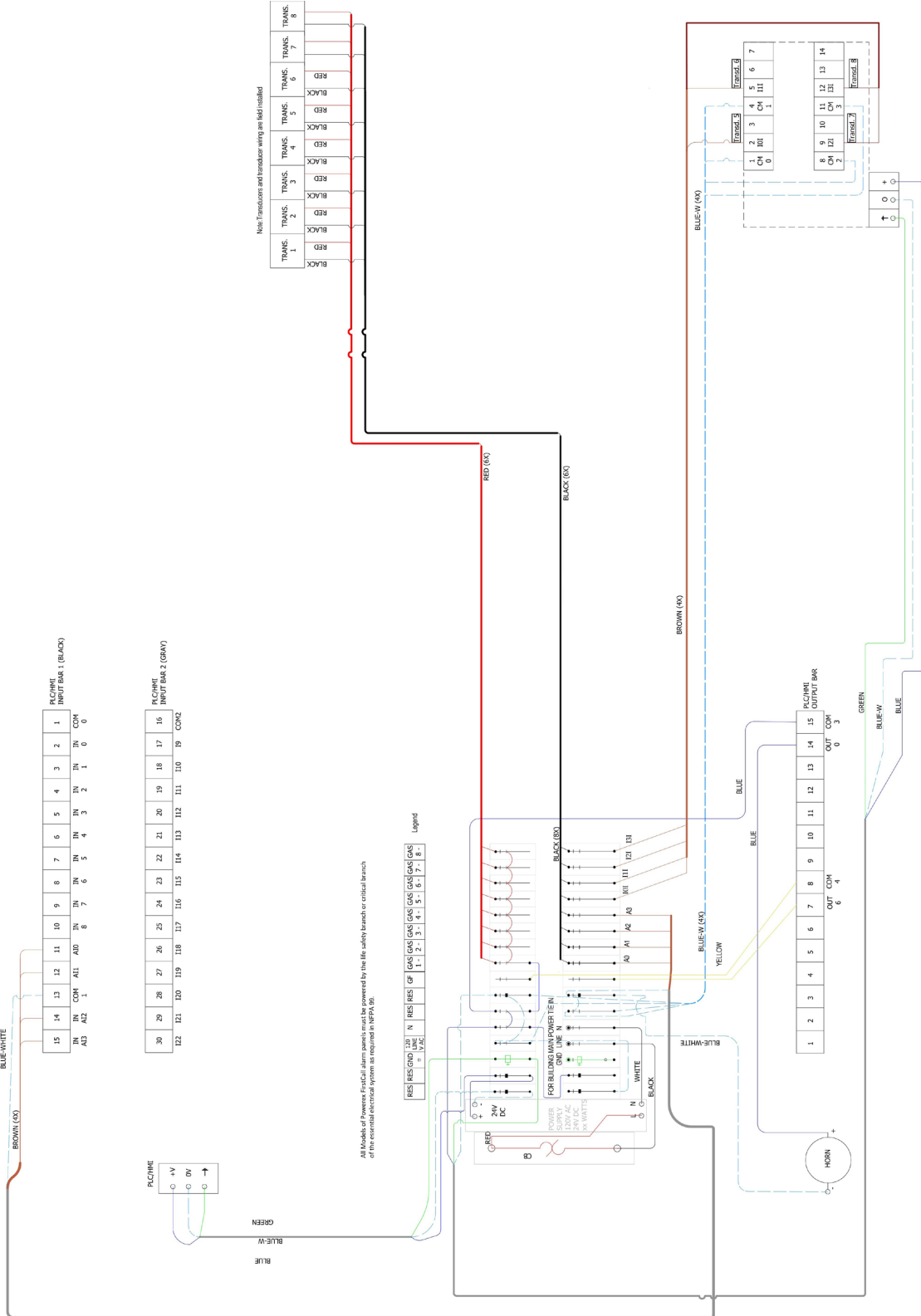

Master Alarm Panel Wiring Schematic

23 Digital Input Master Alarm Panel – AP000M230AJ

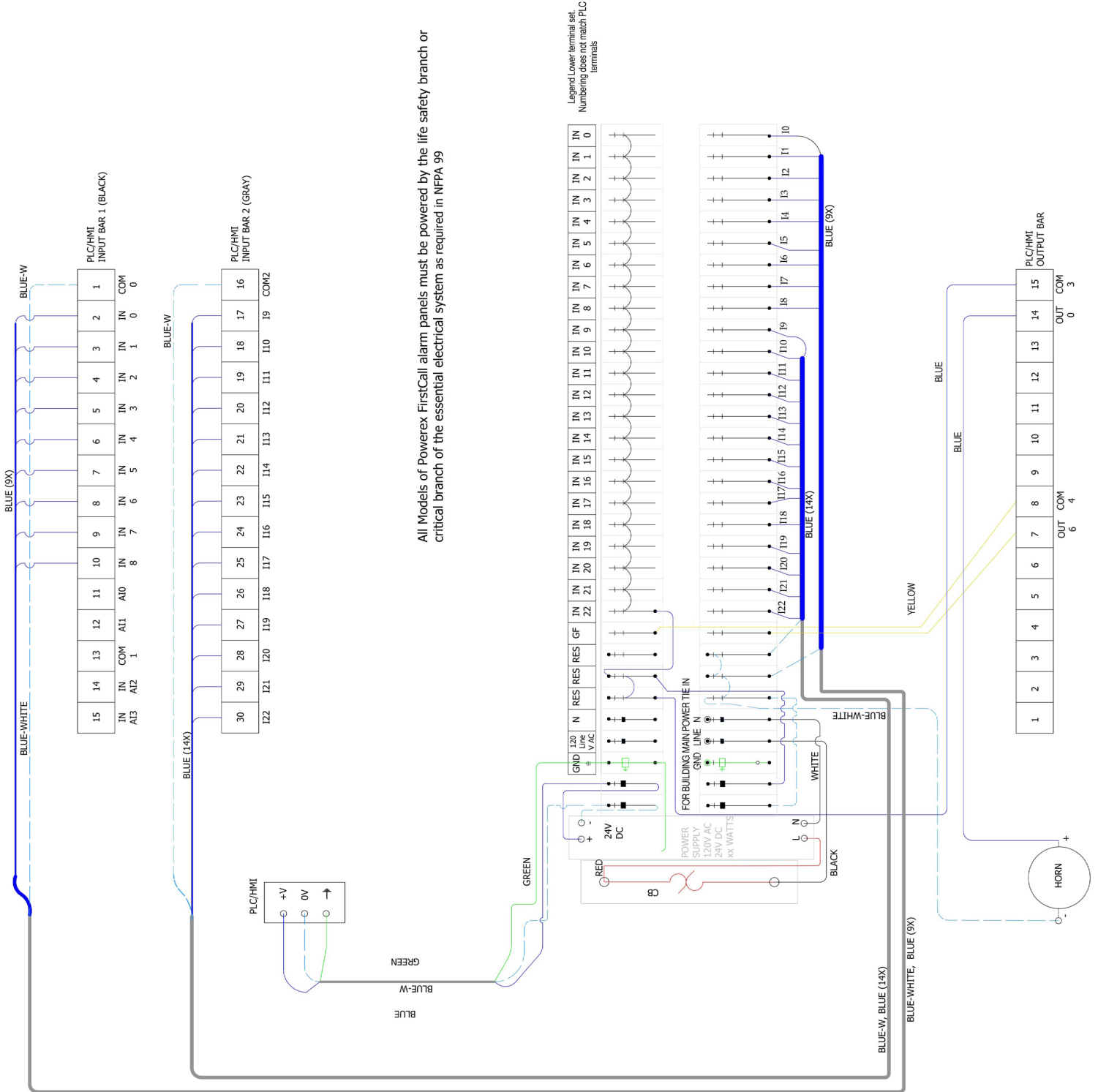

All Models of Powerex FirstCall alarm panels must be powered by the life safety branch or critical branch of the essential electrical system as required in NFPA 99

Master Alarm Panel Wiring Schematic

39 Digital Input Master Alarm Panel – AP000M390AJ

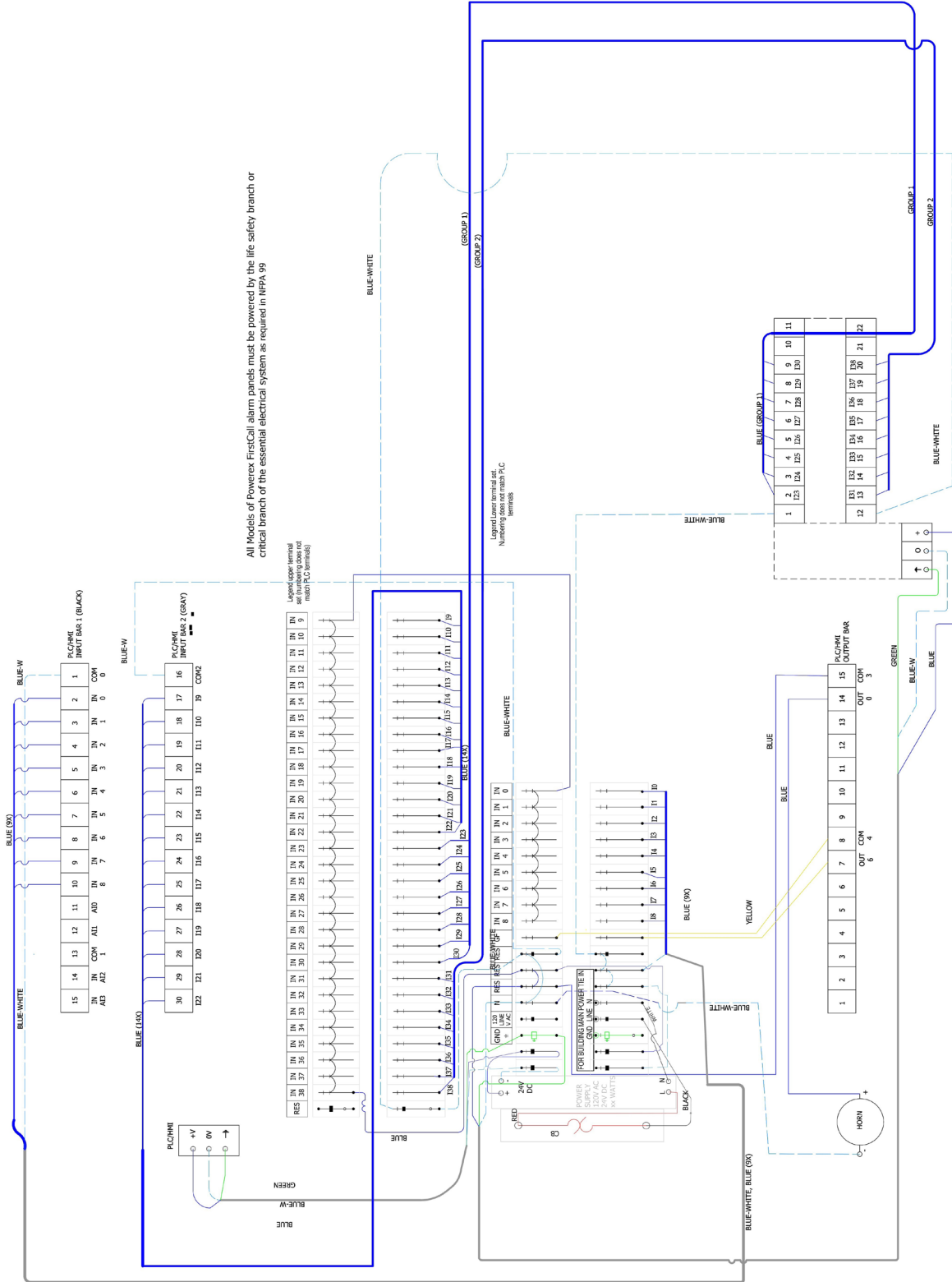

Master Alarm Panel Wiring Schematic

55 Digital Input Master Alarm Panel – AP000M550AJ

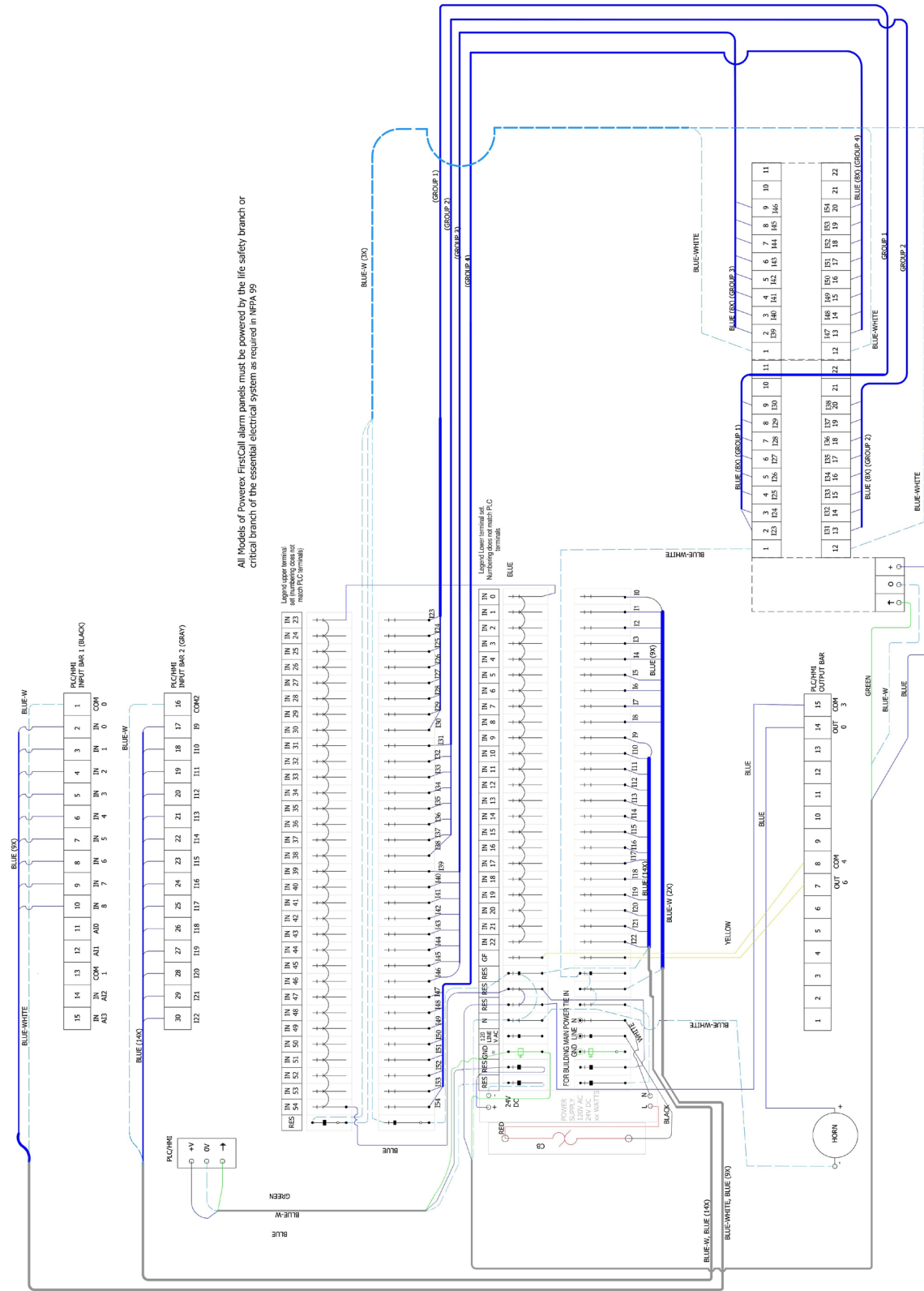

All Models of Powerex FirstCall alarm panels must be powered by the life safety branch or critical branch of the essential electrical system as required in NFPA 99

Legend upper terminal all numbers except first P.C.C terminal

Legend lower terminal all numbers except first P.C.C terminal

Combo Alarm Panel Wiring Schematic

23 Digital Inputs and 1-4 Gas Combo Alarm Panels – AP000C234AJ

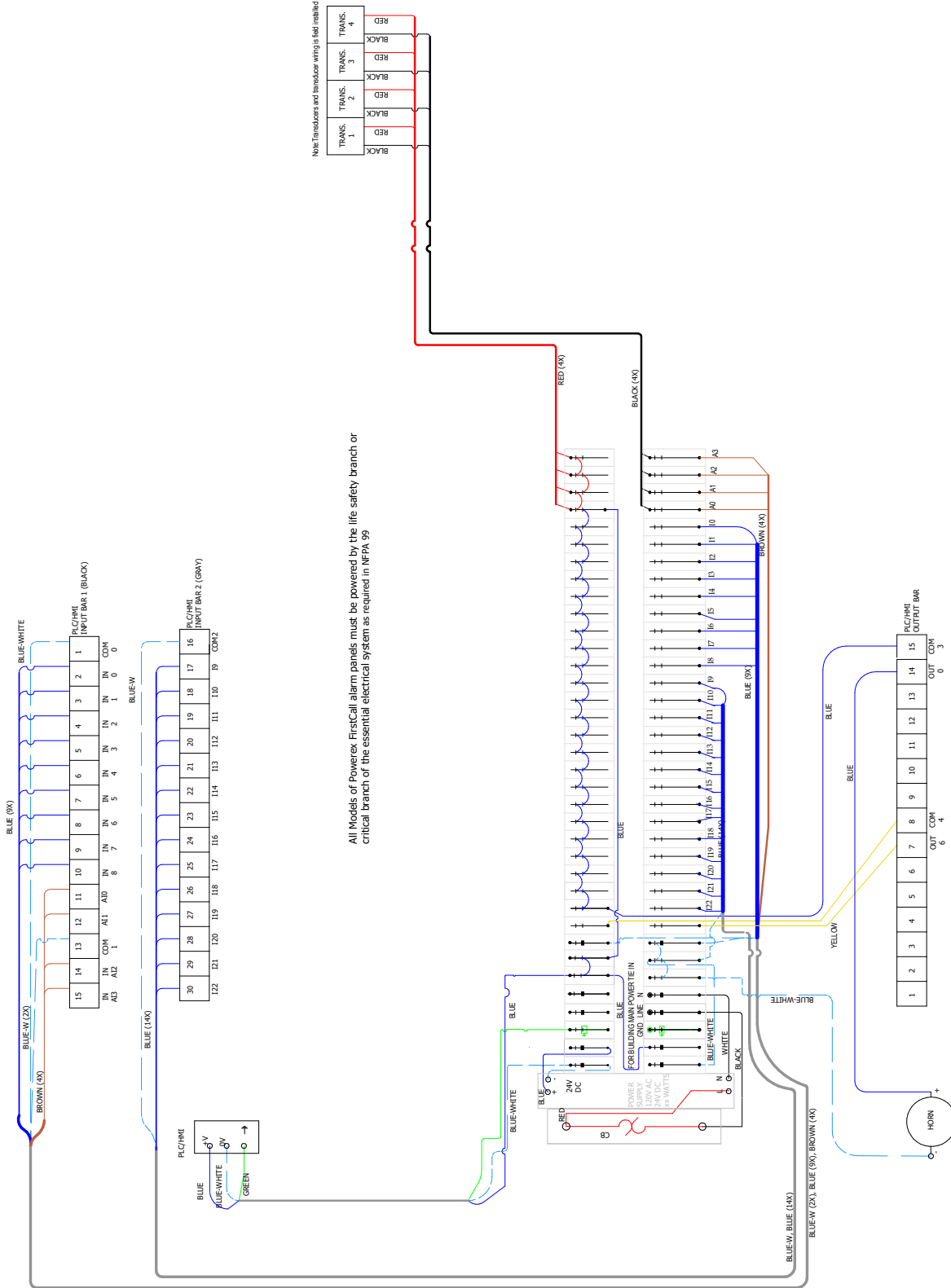

Combo Alarm Panel Wiring Schematic

23 Digital Inputs and 5-6 Gas Combo Alarm Panels – AP000C236AJ

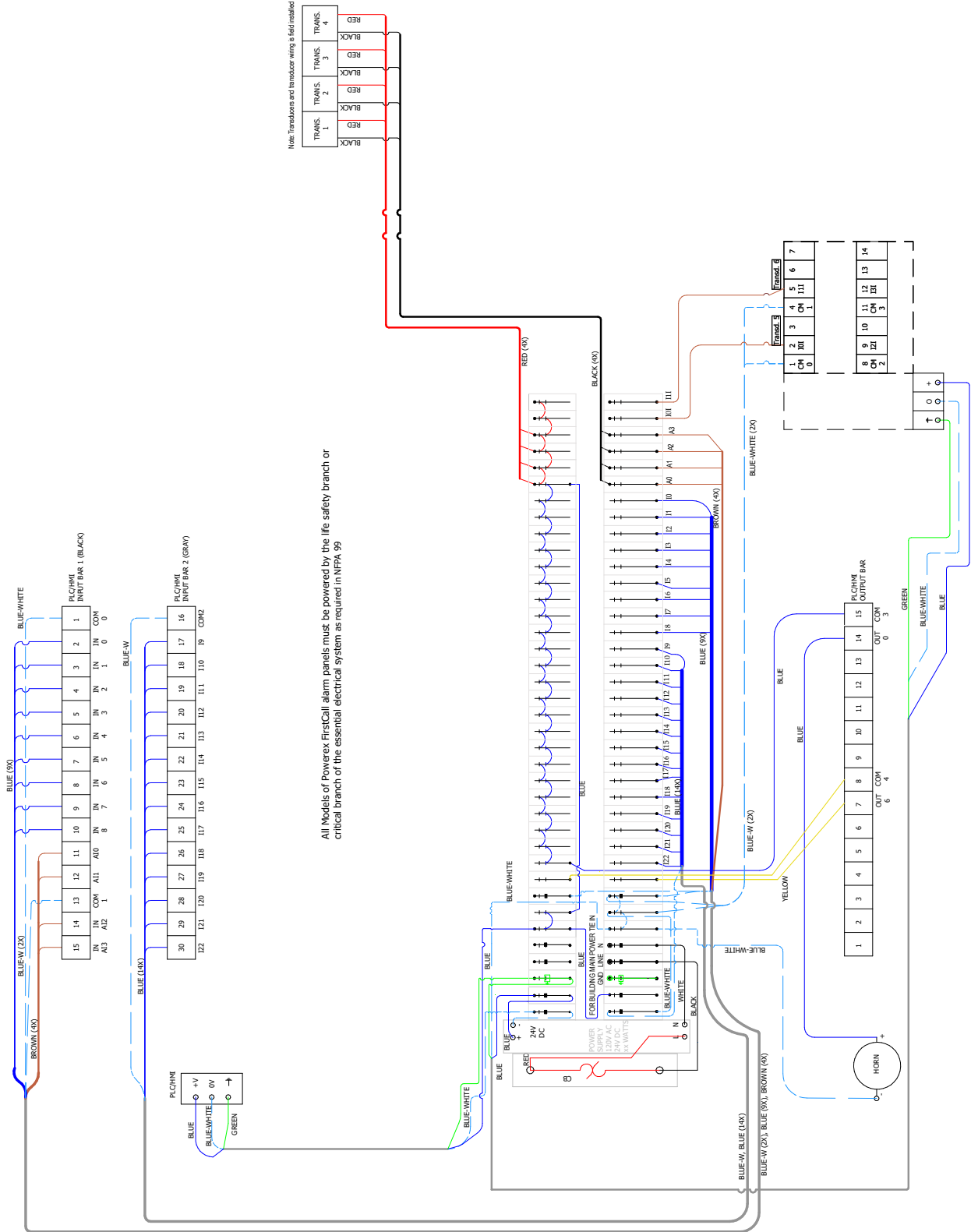

Combo Alarm Panel Wiring Schematic

39 Digital Inputs and 1-4 Gas Combo Alarm Panels – AP000C394AJ

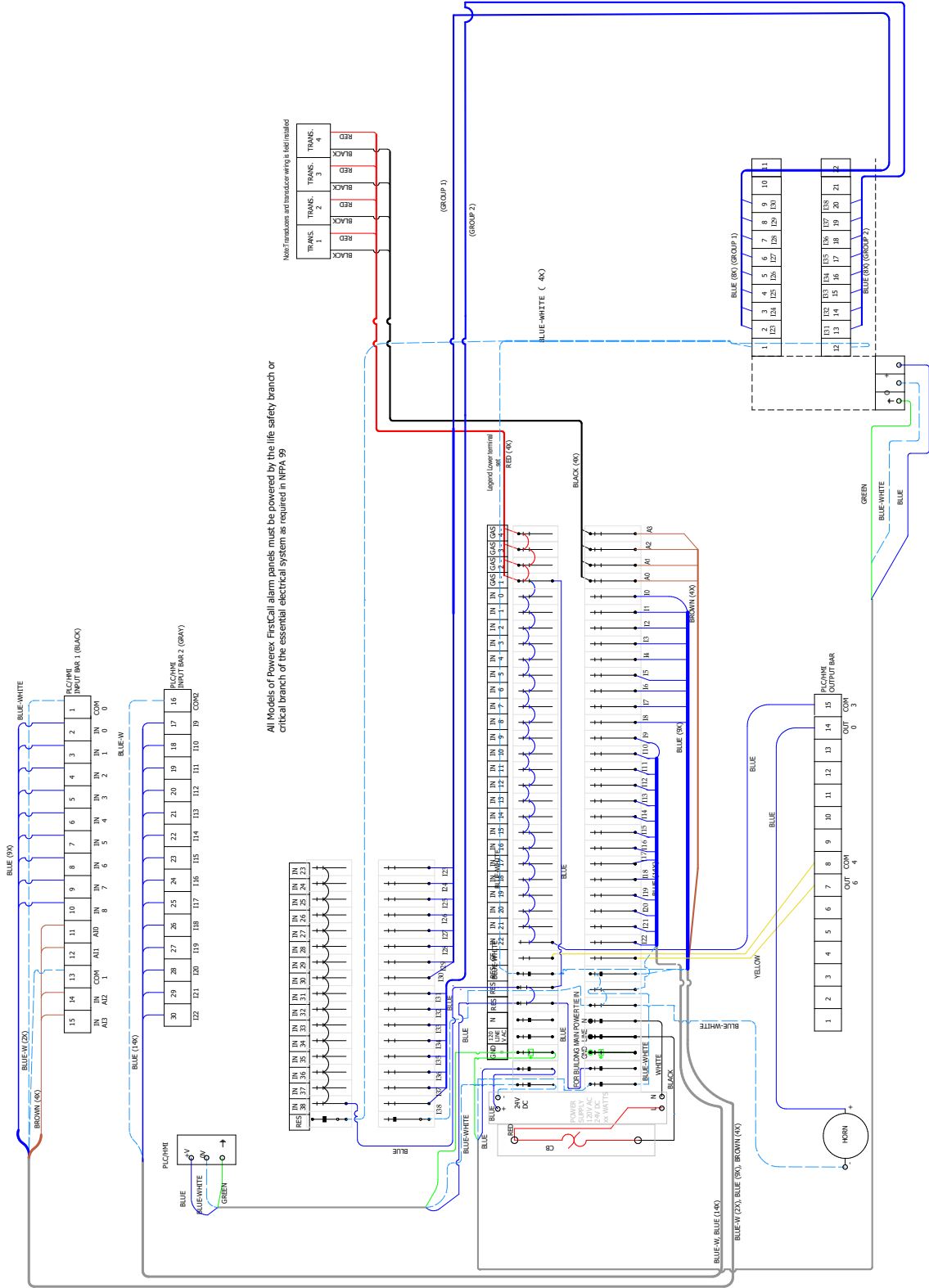

Combo Alarm Panel Wiring Schematic

39 Digital Inputs and 5-6 Gas Combo Alarm Panels – AP000C396AJ

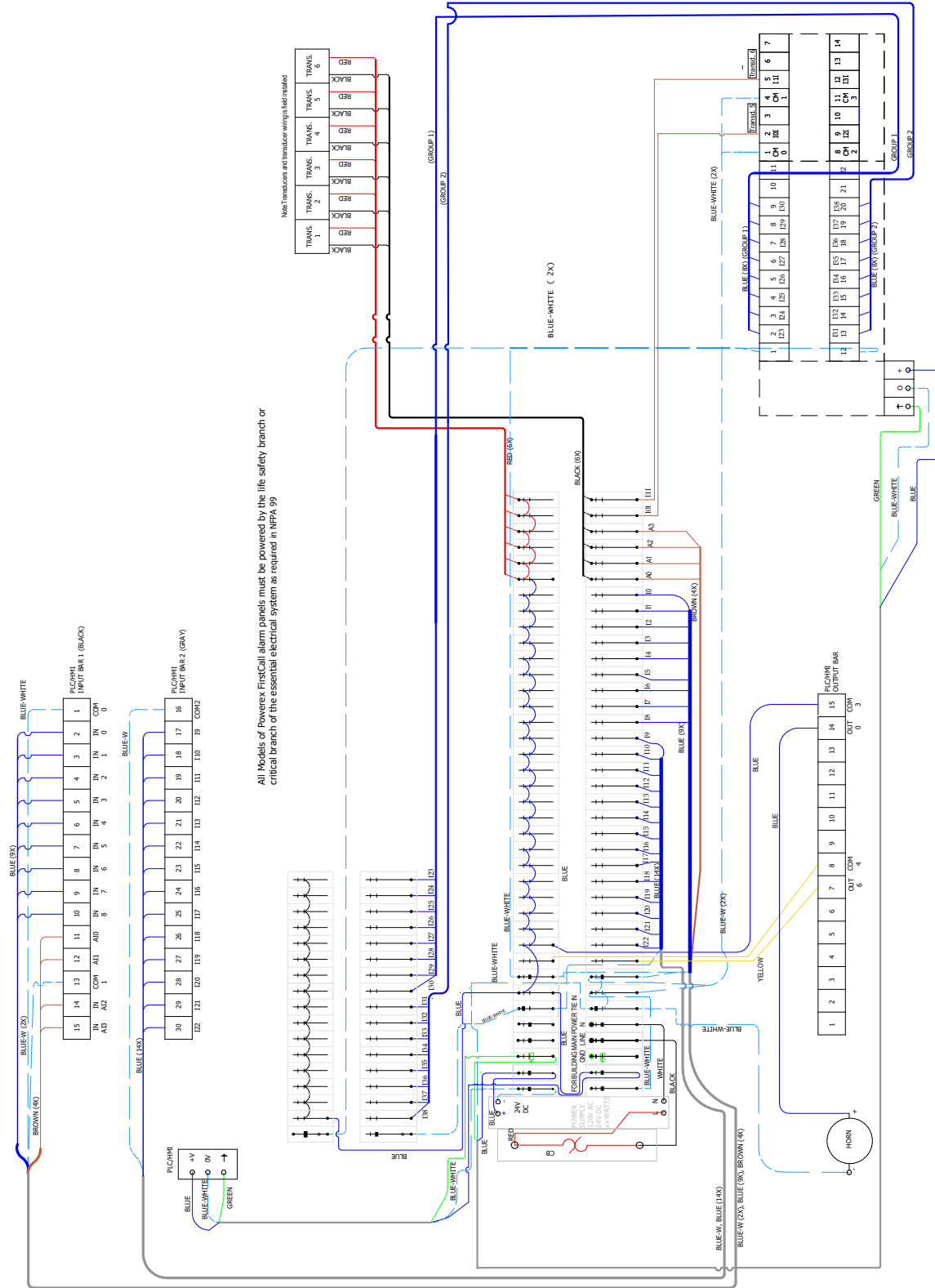

Combo Alarm Panel Wiring Schematic

55 Digital Inputs and 1-4 Gas Combo Alarm Panels – AP000C554AJ

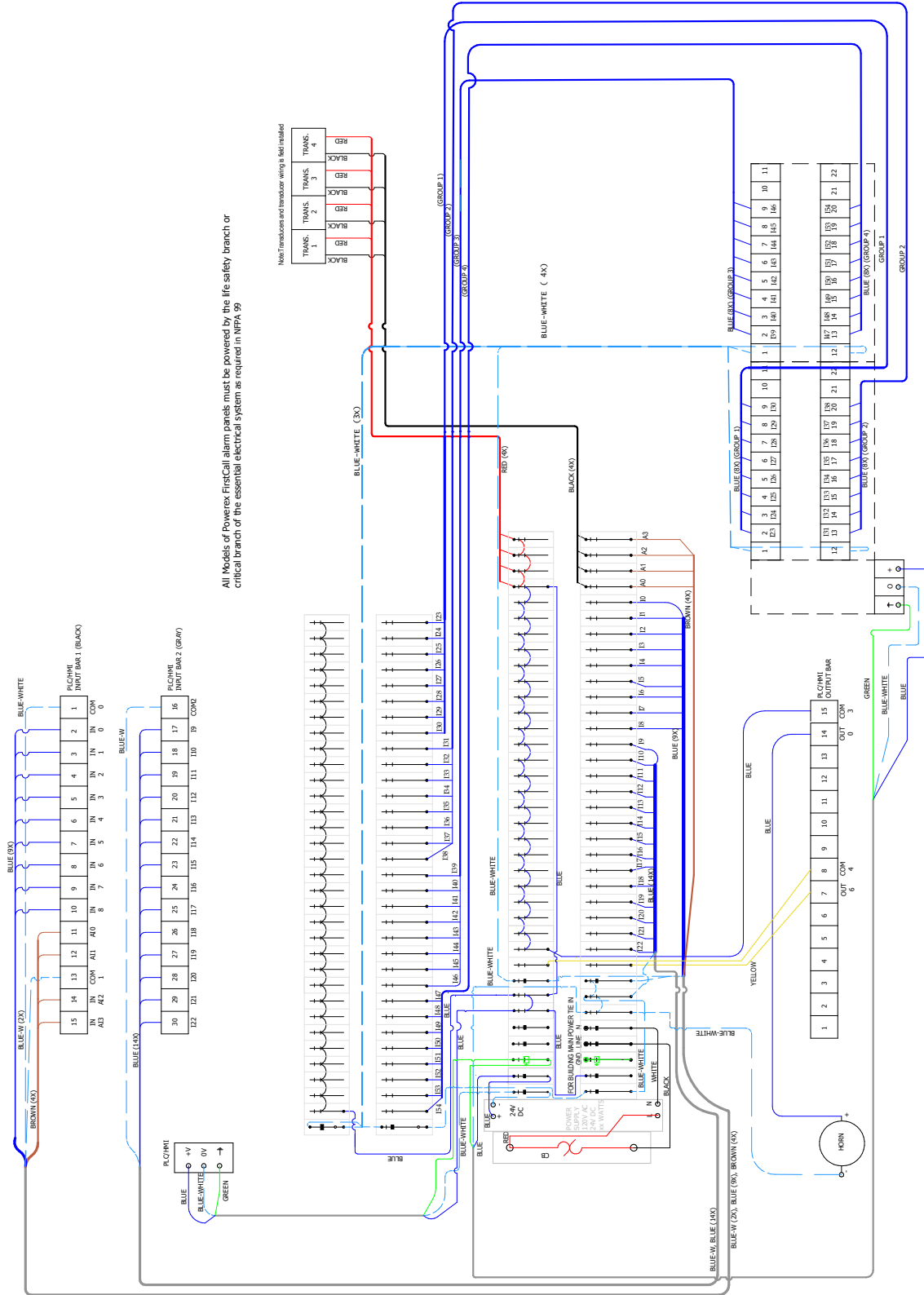

Combo Alarm Panel Wiring Schematic

55 Digital Inputs and 5-6 Gas Combo Alarm Panels – AP000C556AJ

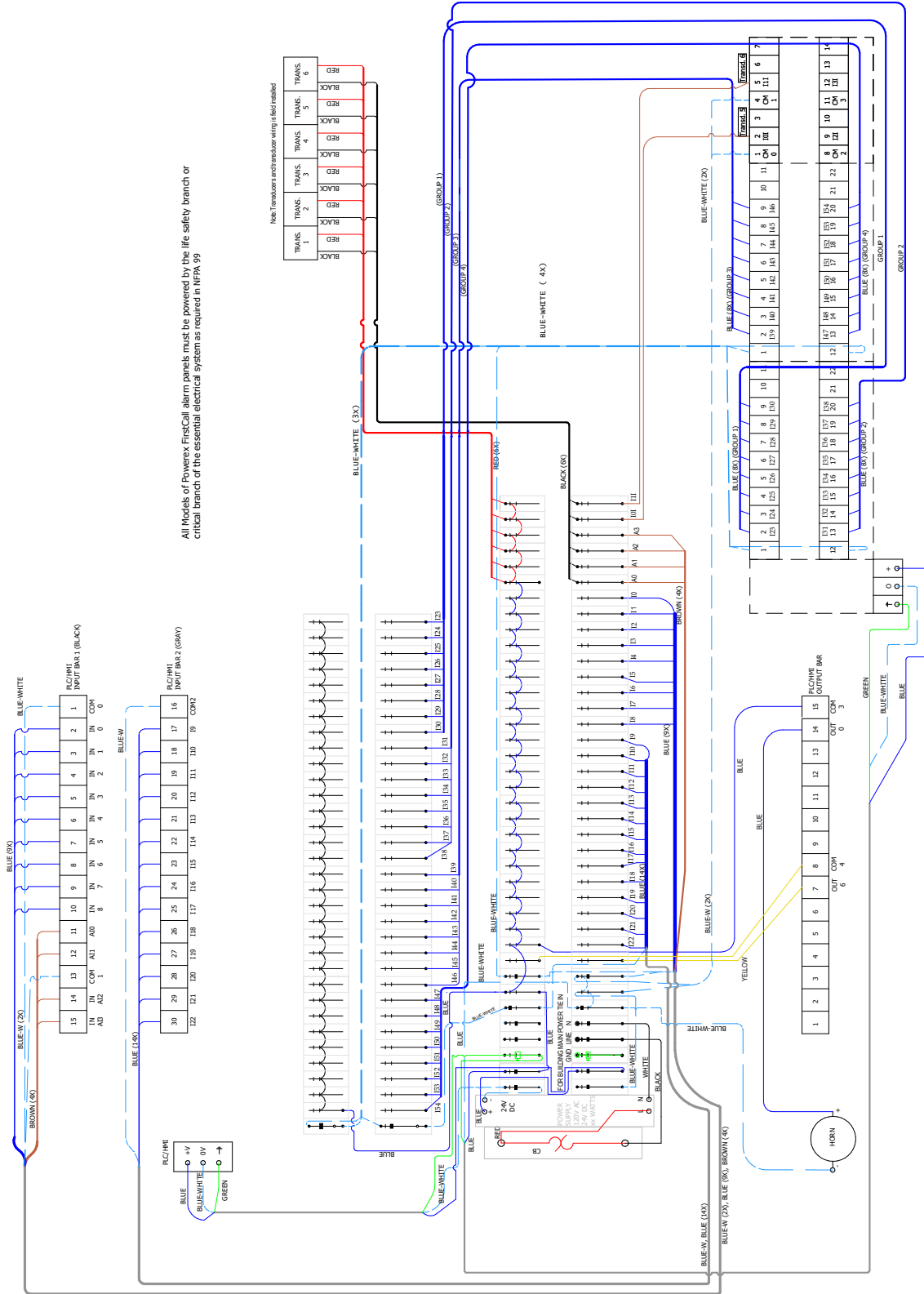

All Models of Powerex FirstCall alarm panels must be powered by the life safety branch or critical branch of the essential electrical system as required in NFPA 99

Setup and Configuration

Login to Settings

Press upper right part of screen for at least 3 seconds.

Window pops up, press the middle button for login.

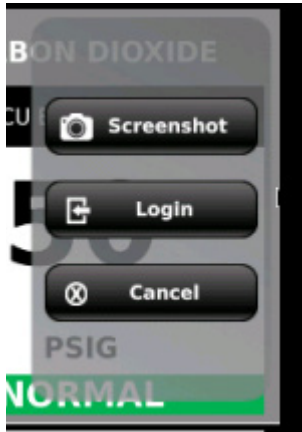

For user select "USER."



Default password is **Pass123**. This password can be changed in the settings screen. **NOTE:** The password is case sensitive.

Keyboard Basics

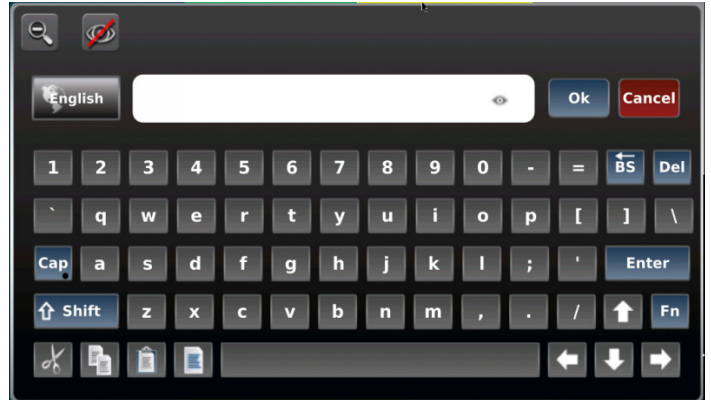

Powerex FirstCall™ Alarm System uses a full QWERTY keyboard to easily add zone names, create customized alarm instructions, and create customized alarm conditions.

The keyboard has the ability to use CAPS lock, as well as cut/copy/paste for when you want to use the same information in a different location.

To maximize the keyboard size to fit the entire screen, press the zoom button in the upper left corner.

The PLC has a USB port on the side. A keyboard or a mouse with a USB connection can plug into the PLC and be used for setup and navigation. There is only 1 USB port, so to use both the keyboard and a mouse, a separate USB splitter is required.

Once the correct password is entered, the alarm panel will now be in "Settings" mode. The Test button at the bottom will be changed to a "Settings" gear icon.



Zone Served Block

Click the lower right black-colored bar on the home screen to add text to the Zone Served Block. There is enough room for 3 lines of text.

Gas Badges (Area & Combo only)

Text can be added to the black-colored bar underneath the gas to further specify the location where each gas is being used.

Settings Menu

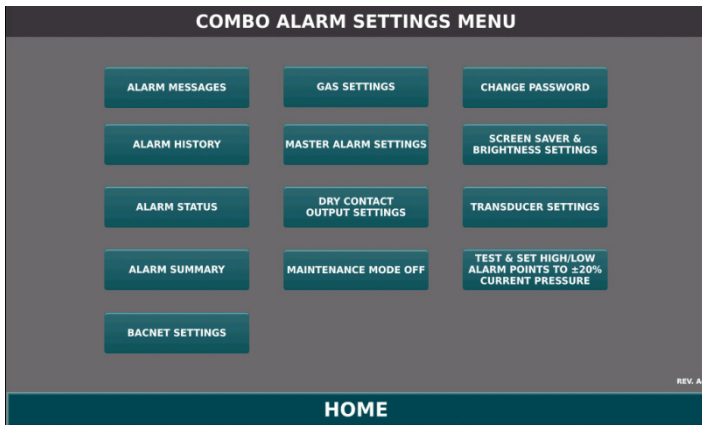

The Area Alarm settings screen will not have a button for “Master Alarm Settings.”

The Master Alarm settings screen will not have button for “Gas Settings”, “Transducer Settings”, and “Test & Set High/Low Alarm Points to +/- 20% Current Pressure.”

Basic Settings for All Alarm Panel Types (Area, Master, & Combo)

Alarm Messages

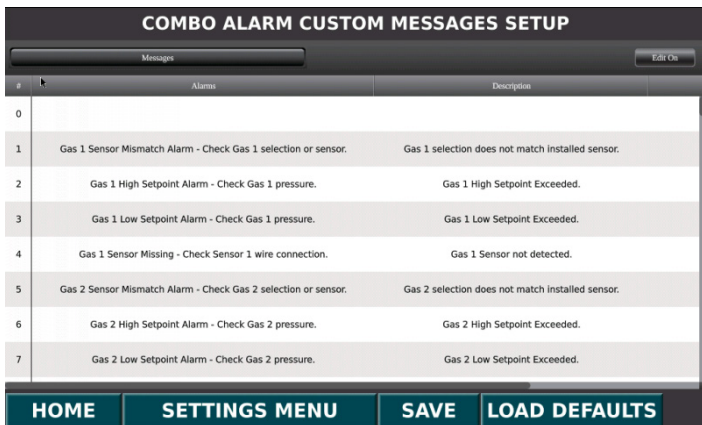

The Powerex FirstCall™ Alarm System allows the user to program specific instructions for each alarm event.

To edit the alarm instructions, first press the “Edit On” button in the upper right corner.

The default alarm message is under the Alarms column on the left. To edit, press the specific alarm condition.

Use the keyboard to add, delete, or change as necessary.

Press the “SAVE” button at the bottom to save changes.

Press the “SETTINGS MENU” button to return to the settings screen, or the “HOME” button to return to the home screen.

Alarm History

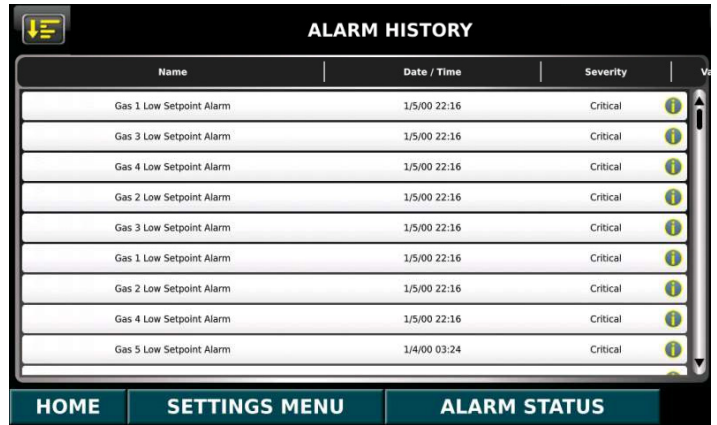

The Alarm History screen shows a record of all alarm events up to 32, including the specific alarm condition and the date and time of the alarm event.

This screen is also accessible via the home screen by pressing the status bar at the lower left part of the screen. The status bar will either be green colored and read “NORMAL” or red colored with the current alarm event.

This screen also has the ability to sort the alarm history list by a number of different criteria. The default sort is “Time”. The alarm history list can be sorted differently by pressing the Alarm History Sort button in the upper left corner.

Alarm Status

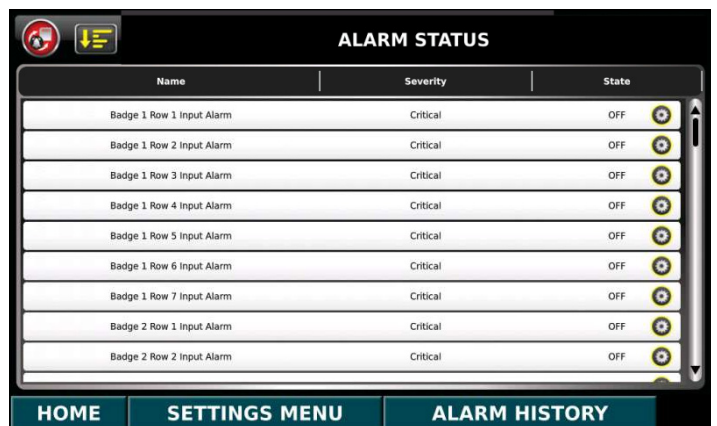

The Alarm Status screen shows a list of all possible alarm conditions for the maximum number of gases and input signals available in the Powerex FirstCall™

Alarm System.

The Area alarms all begin with Gas #(1 thru 8) and the Master alarms all begin with Badge #(1 thru 12).

The default Area alarms for each individual gas are as follows:

- Sensor Mismatch Alarm
- High Setpoint Alarm
- Low Setpoint Alarm
- Sensor Missing

The Master alarm digital input signals are grouped together under one gas badge and are indicated by the source gas (these are edited in the “Master Alarm Settings” screen).

Up to 7 digital input signals are available for each badge, or piece of source equipment.

The Alarm Status screen has the same sorting ability as the Alarm History screen – just press the sort button in the upper left corner.

Alarm Summary

The Alarm Summary screen shows a list of all active alarm conditions.

This screen is also accessible from the red bar with the scrolling marquee at the bottom of the screen that pops up during an alarm event. Press the “list” icon, which is second from the left on the red bar.

Alarm conditions can be acknowledged and cleared on this screen. Further details are given in the “Alarm Event” section under “Operation.”

Gas Settings

COMBO ALARM GAS SETUP						
Press an entry or selection box directly below to enable override of default values.			RETURN LOW/HIGH & UOM TO DEFAULT	SET TO ±20% CURRENT PRESSURE		
1	OXYGEN	ICU East Zone 2	PSIG	44.0	66.0	
No.	Edit	Gas Type	Location	UOM	LOW	HIGH
1.		OXYGEN	ICU East Zone 2	PSIG	44.0	66.0
2.		MEDICAL AIR	ICU East Zone 2	PSIG	44.0	66.0
3.		CARBON DIOXIDE	ICU East Zone 2	PSIG	40.0	60.0
4.		NITROUS OXIDE	ICU East Zone 2	PSIG	40.0	60.0
5.		NITROGEN	ICU East Zone 2	PSIG	140.0	200.0
6.		MEDICAL VACUUM	ICU East Zone 2	IN HG	12.0	999.0

This screen is only applicable to Area alarms and Combo alarms.

In the gas settings page, you are able to change the medical gas type, add/subtract a gas, designate the location monitored for each gas, and manually change the high/low alarm settings. **NOTE:** All Powerex FirstCall™ Area Alarms are pre-programmed from the factory with the correct medical gases and default high/low alarm settings.

Location where each gas is being used can be entered in this screen as well as via the home screen.

To edit/add/delete a gas badge, first press the edit button next to the row number on the left. This makes that row active in the editing row at the top highlighted in yellow.

The gas is edited in the first column, and can be selected from a preloaded list of NFPA 99 medical gases. The correct NFPA 99 color combination is automatically selected when a gas is selected.

NFPA 99 Gas Color Combinations:

Oxygen	Instrument Air	O2 / He
Medical Air	Helium	Lab Air
Medical Vacuum	Surgical Air	Lab Vacuum
Nitrous Oxide	Argon	Oxygen Hyp.
Nitrogen	CO2 / O2	Medical Air Hyp.
Carbon Dioxide	O2 / CO2	Carbon Dioxide Hyp.
WAGD	He / O2	AGSS

The Unit of Measure (UOM) for each gas can be changed. For all NFPA 99 applications, PSIG should be selected for all positive pressure gases and IN HG should be selected for Medical Vacuum, WAGD, and Lab Vacuum.

High/Low settings default settings for each gas are as follows:

Medical Gas	Low Setpoint (PSI)	High Setpoint (PSI)
Oxygen	44	66
Medical Air	44	66
Medical Vacuum	12 inHg	N/A
Nitrous Oxide	40	60
Nitrogen	140	200
Carbon Dioxide	40	60
WAGD	12 inHg	N/A
Instrument Air	140	200

High/Low settings can be changed one of two ways:

1. Manually input.
2. Automatically set to +/- 20% of current pressure using the button at the top right. This is the best way to ensure accurate NFPA 99 compliant high/low settings. This feature is also available on the Settings Menu page.

Press the "SAVE" button at the bottom to save changes.

Press the "SETTINGS MENU" button to return to the settings screen or the "HOME" button to return to the home screen.

Master Alarm Settings

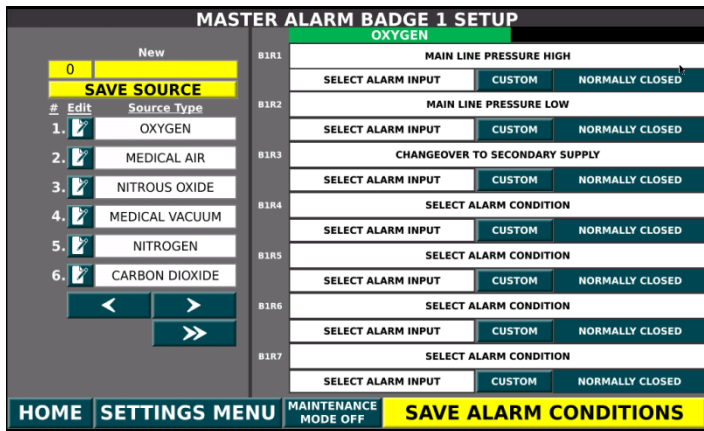

The Master Alarm Settings screen is where the source equipment gas is identified and alarm signal inputs are assigned. Up to 12 Source Badges are available, with up to 7 digital input signals available for each source badge. Please note that Powerex FirstCall™ Master Alarm panels are available in either 23, 39, and 55 digital inputs.

To create a new source badge, press the "Edit" icon near the row number on the left. The row number will appear in the yellow highlighted row at the top. Press the yellow box to the right to bring up a preloaded list of NFPA 99 medical gases and select one.

Press "SAVE SOURCE" underneath to add the new source badge to the list of Source Types.

The table to the right will then be populated with selectable boxes and a heading with the selected source gas. To add the digital alarm inputs, press "SELECT ALARM CONDITION". A list of preloaded NFPA 99 alarm signals will come up to select from. There is also an option to manually add the alarm signal description by

pressing "CUSTOM."

To match the alarm condition with the correct location on the terminal blocks, press "SELECT ALARM INPUT" and select the corresponding terminal block number of the digital input wires.

The default circuit setting is "NORMALLY CLOSED". To change it to "NORMALLY OPEN", toggle the button that says "NORMALLY CLOSED" and it will switch.

To save all changes, press "SAVE ALARM CONDITIONS" at the bottom right of the screen.

Press the "SETTINGS MENU" button to return to the settings screen or the "HOME" button to return to the home screen.

Source Gas Description

Additional text can be added for each gas badge. For example, if there are 2 Medical Air Compressors to be monitored, this space would be used to identify each one.

To add a description to the Master Alarm gas badge, press the gas badge on the home screen to view the individual alarm conditions.

Press the black box on the upper right corner of the screen to pull up a the keyboard

Enter description. The description will be displayed in the black strip of the gas badge on the home screen.

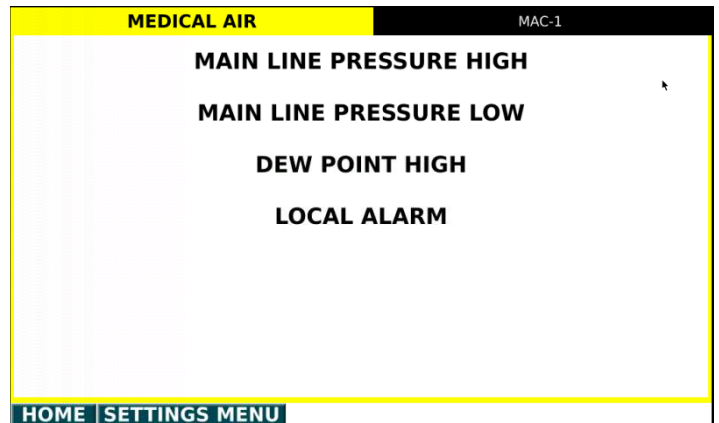

OXYGEN	MEDICAL AIR	NITROUS OXIDE
NORMAL	MAC-1	NORMAL
NITROGEN	CARBON DIOXIDE	MEDICAL VACUUM
NORMAL	NORMAL	NORMAL
WAGD	INSTRUMENT AIR	MEDICAL AIR
NORMAL	NORMAL	MAC-2
NORMAL	NORMAL	NORMAL
<div style="display: flex; justify-content: space-between; align-items: center;"> NORMAL NORTHEAST WING DENVER GENERAL </div>		

green and displays “NORMAL” will now be yellow and display “MAINTENANCE.”

MASTER ALARM	OXYGEN	MEDICAL AIR	CARBON DIOXIDE
OXYGEN	ICU East Zone 2	ICU East Zone 2	ICU East Zone 2
MEDICAL AIR	52	50	50
NITROUS OXIDE	PSIG	PSIG	PSIG
MEDICAL VACUUM	NORMAL	NORMAL	NORMAL
NITROGEN	NITROUS OXIDE	NITROGEN	MEDICAL VACUUM
CARBON DIOXIDE	ICU East Zone 2	ICU East Zone 2	ICU East Zone 2
	50	171	16
	PSIG	PSIG	IN HG
	NORMAL	NORMAL	NORMAL
<div style="display: flex; justify-content: space-between; align-items: center;"> MAINTENANCE Denver General East Zone </div>			

Dry Contact Output Settings

DRY CONTACT ALARM OUTPUT SETUP			
OUT 0	SET TO GENERAL FAULT		
OUT 1	INTERNAL BATTERY LOW	OUT 11	GENERAL FAULT
OUT 2	GENERAL FAULT	OUT 12	GENERAL FAULT
OUT 3	GENERAL FAULT	OUT 13	GENERAL FAULT
OUT 4	GENERAL FAULT	OUT 14	GENERAL FAULT
OUT 5	GENERAL FAULT	OUT 15	GENERAL FAULT
OUT 6	GENERAL FAULT	OUT 16	GENERAL FAULT
OUT 7	GENERAL FAULT	OUT 17	GENERAL FAULT
OUT 8	GENERAL FAULT	OUT 18	GENERAL FAULT
OUT 9	GENERAL FAULT	OUT 19	GENERAL FAULT
OUT 10	GENERAL FAULT	OUT 20	GENERAL FAULT

HOME
SETTINGS MENU
➤

Standard dry contact output is on terminal block “00” for General Fault.

Additional dry contact output terminal blocks are available by special order. Please contact your Powerex representative for more information.

All digital output signals are Normally Closed.

Maintenance Mode (image toggled)

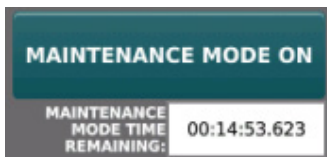

When Maintenance Mode is toggled, the alarm horn will not activate during a normal alarm event. This allows a technician to perform maintenance without setting off the loud alarm.

Maintenance mode will automatically toggle back to normal after 15 minutes. A timer is displayed below the button.

The lower right bar on the home screen that is typically

Change Password

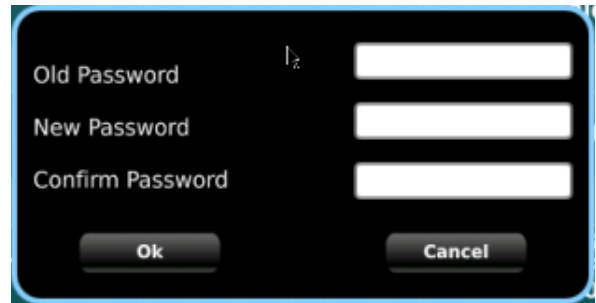

To change the password, press the “Change Password” button, enter the old password, enter the desired new password, and confirm the desired new password.

Screen saver and brightness settings

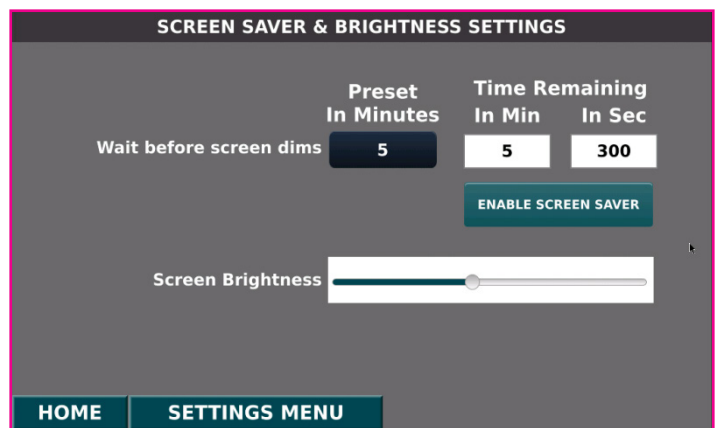

The Powerex FirstCall™ Alarm System is factory-set with a 5 minute screen saver. The screen saver dims the panel to 10% after 5 minutes. This time limit can be changed. The boxes to the right show the time remaining until the screen saver is enabled.

To disable the screen saver, press the “DISABLE SCREEN SAVER” button.

Screen brightness is set to 50% from the factory. This can be changed higher or lower depending on preference.

To maximize the lifespan of the screen, Powerex advises that the screen saver remain enabled and the default screen brightness be no higher than 50%.

Transducer Settings

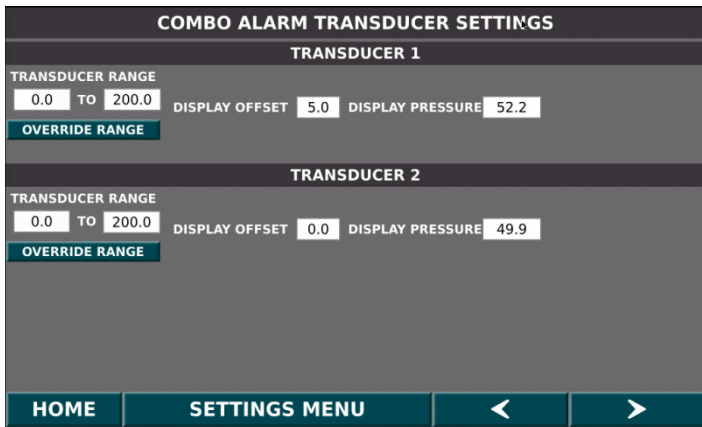

The Powerex FirstCall™ Area and Combo Alarm Systems come with the ability to adjust the displayed value of the pressure, as well as override the standard pressure range of the installed transducer.

For example, if the transducer reads 52, and the desired display is 50, enter 2 under “display offset.”

Use the arrows at the bottom to scroll through the different transducers if there are more than 2.

The Transducer Range settings should never have to be overridden by a user. If an alarm panel is required to be expanded with a new gas that falls outside the standard range, please contact Powerex Technical Service for instruction

Test & Set High/Low Alarm Points to +/- 20% Current Pressure



This unique feature easily allows for compliance with NFPA 99 2018 edition 5.1.9.4.2, stating that Area Alarm Panels for medical gas systems shall indicate if the pressure in the lines in the area being monitored increases or decreases by 20 percent from the normal

line pressure.

The Powerex FirstCall™ Alarm System will automatically calculate the high/low set points based on the current pressure measured by the transducers.

The low limit for Medical Vacuum and WAGD systems will still stay at 12” Hg even when this feature is used.

The high/low settings will also appear on the gas badge on the home screen for 5 seconds.

BACNet Settings

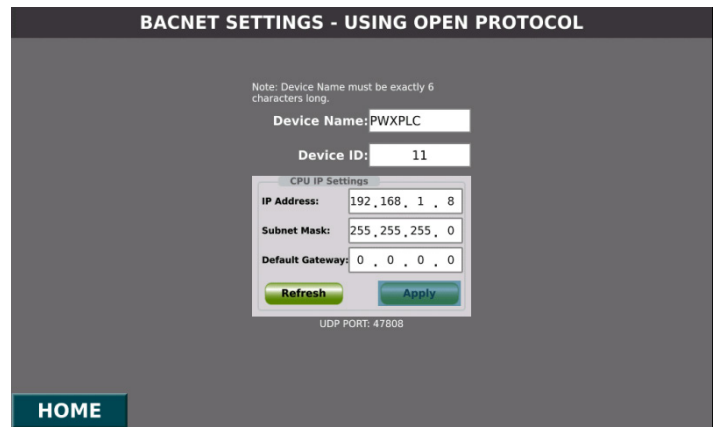

Enter desired device name – must be exactly 6 characters. Default name is always PWXPCL.

Enter desired Device ID number – any number between 0 and 255.

Address for the PLC is already preloaded, but is able to be changed if required.

Subnet Mask is defaulted to 255, 255, 255, 0 – this can be changed if required.

Default Gateway is set at 0, 0, 0, 0 – this can be changed if required.

Press “Apply” to save settings, and the PLC will reboot after pressing “OK.”

See the BACNet Object Names chart in Appendix A for list of abbreviated names for alarm conditions, gas pressures, and set points that will display on the BACNet explorer.

Operation

TEST Feature

To test the alarm horn, press the “TEST” button in the center of the lower bar. A caution window will pop up, warning the user that the alarm horn will sound and asking to confirm. To proceed with the test, press “OK.”

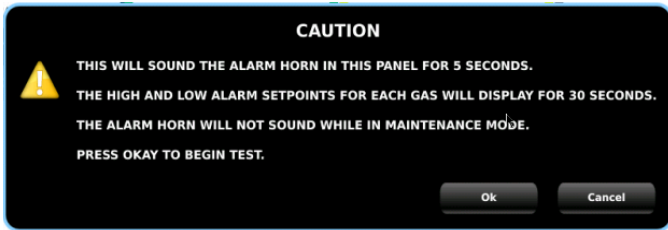

The alarm horn will sound for 5 seconds.

For Area and Combo Alarms, the high/low pressure settings will display on the gas badge for 30 seconds.

Master Alarm Inputs

The Master Alarm panel groups each alarm signal input under the designated source gas. To see the detailed alarm signals, press the gas badge.

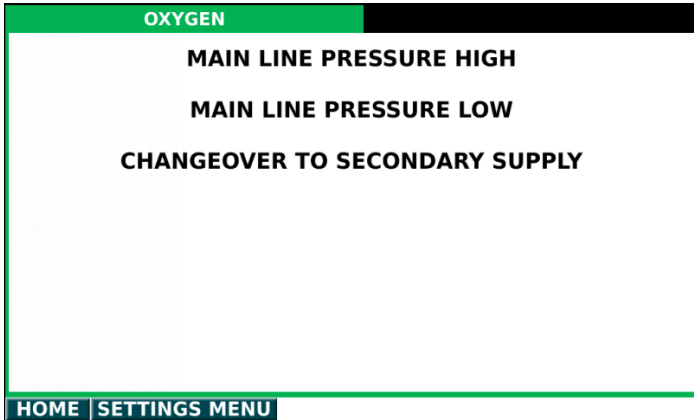

Alarm Event

Area Alarms – there are 4 different alarm conditions for area alarm gas badges:

1. Missing – panel does not detect a transducer connected.

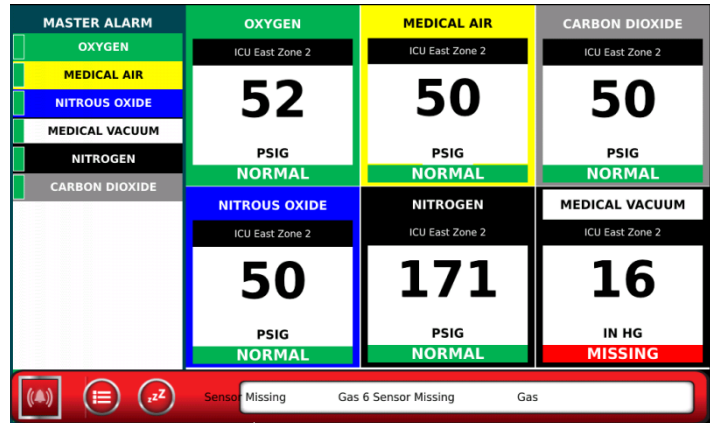

2. Mismatch – panel detects a transducer connected, but it is the wrong gas type.

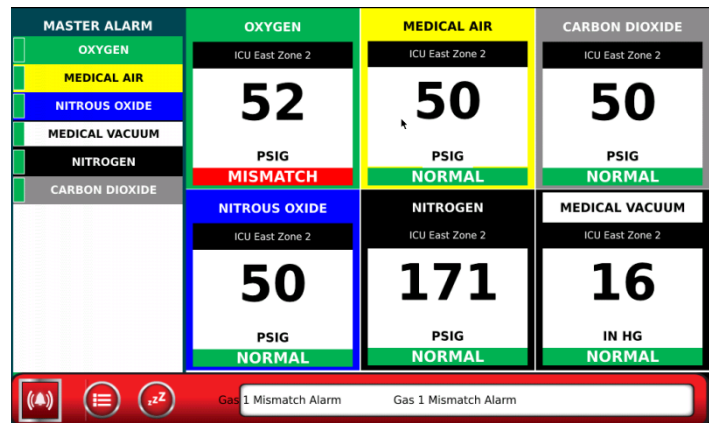

3. Low – gas pressure less than 20% below nominal.

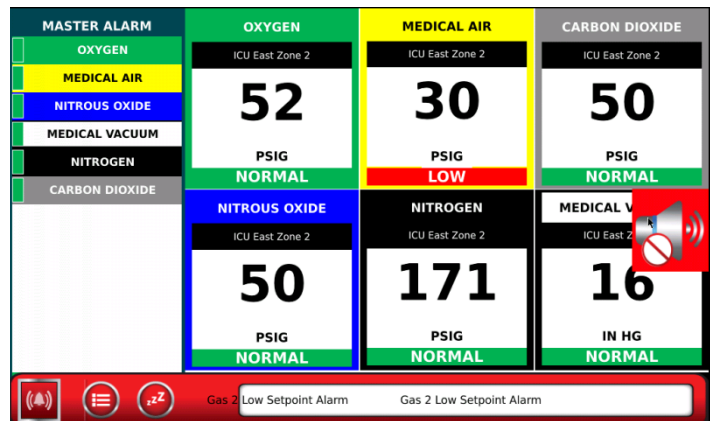

4. High – gas pressure greater than 20% above nominal.

MASTER ALARM	OXYGEN	MEDICAL AIR	CARBON DIOXIDE
OXYGEN	ICU East Zone 2	ICU East Zone 2	ICU East Zone 2
MEDICAL AIR	52	50	50
NITROUS OXIDE	PSIG	PSIG	PSIG
MEDICAL VACUUM	NORMAL	NORMAL	NORMAL
NITROGEN	NITROUS OXIDE	NITROGEN	MEDICAL VACUUM
CARBON DIOXIDE	ICU East Zone 2	ICU East Zone 2	ICU East Zone 2
	75	171	16
	PSIG	PSIG	IN HG
	HIGH	NORMAL	NORMAL

Gas 4 High Setpoint Alarm Gas 4 High Setpoint

Master Alarm – Any Signal From the Source Equipment

In the event of an alarm on a Master Alarm panel, the source gas that is experiencing the alarm will change from the green “NORMAL” box to a flashing red “INPUT” box.

OXYGEN	MEDICAL AIR	NITROUS OXIDE
INPUT	NORMAL	NORMAL
NITROGEN	CARBON DIOXIDE	MEDICAL VACUUM
NORMAL	NORMAL	NORMAL
WAGD	INSTRUMENT AIR	MEDICAL AIR
NORMAL	NORMAL	NORMAL

1 Row 3 Input Alarm Badge 1 Row 3 Input Alarm Badge 1 Row 3 Input A

To see the specific alarm, press the gas badge that’s in alarm to view the list of alarm conditions. The specific alarm will be highlighted in red.

OXYGEN
MAIN LINE PRESSURE HIGH
MAIN LINE PRESSURE LOW
CHANGEOVER TO SECONDARY SUPPLY

Badge 1 Row 3 Input Alarm Badge 1 Row 3 Input Alarm Badge 1 Row

Silencing the Alarm



In the event of an alarm, pressing the silence button will silence the horn indefinitely. The scrolling marquee at the bottom will remain.

Scrolling Marquee

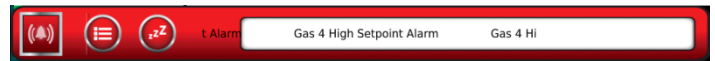

The scrolling marquee displays all active alarm conditions.

Zzz button – “snooze” button, only minimizes the scrolling marquee.

Scrolling marquee will remain until:

- Alarm condition is remedied or acknowledged – acknowledge by pressing the Alarm Summary button (second from the left) to get to the Alarm Summary Screen.
- Pressing the flashing bell icon at the very left will temporarily hide the scrolling marquee, but unless the alarm condition is remedied or acknowledged, it will reappear after a short period of time.

Maintenance

⚠ CAUTION For personal safety, lock out and tag out the associated circuit breaker disconnect for the source of 120V AC power. *Attention: Pour votre sécurité personnelle, verrouillez et étiquetez le sectionneur du disjoncteur associé pour la source d'alimentation de 120 V CA.*

⚠ CAUTION For personal safety and to avoid damage to the alarm, ensure that the circuit breaker is in the OFF position. *Attention: Pour votre sécurité personnelle et pour éviter d'endommager l'alarme, assurez-vous que le disjoncteur est en position OFF.*

Cleaning

Be sure to use a microfiber cloth or soft lint-free cloth when cleaning any smudges off of the HMI. Do not use a paper towel or tissue paper, wet or dry. Do not apply an excessive amount of pressure to the screen to prevent cracking.

Battery

The alarm panel includes an onboard battery to maintain memory in the event of a power outage.

Low battery power will trigger an alarm – replace with a standard CR2032 battery.

NOTE: In this particular case, the AC power to the alarm panel must be kept on during battery replacement. Otherwise all saved settings will be lost if the battery is removed while power is disconnected

Maintenance Mode

Toggling the Maintenance Mode button will allow settings to be changed on the alarm panel without triggering an audible alarm. Maintenance mode is automatically turned off after 15 minutes. A timer is shown near the button once it's activated. On the main screen, the Green "Normal" bar changes to Yellow "Maintenance."

Parts Maintenance List

Ref. Number	Description	Part Number
	Transducers	
	Oxygen	TDCR-O2
	Medical Air	TDCR-AIR
	Medical Vacuum	TDCR-VAC
	Nitrous Oxide	TDCR-N2O
	Nitrogen	TDCR-N2
	Carbon Dioxide	TDCR-CO2
	WAGD	TDCR-WAGD
	Instrument Air	TDCR-INST
	Terminal Blocks	PE000652AV
	Snap-in Plugs	SL057170AV
	Micro SD Card	PE000467AV
	Horn	PE001011AV
	Riser	ST980760AV
	Circuit Breaker	PE0013101AV
	Power Supply	PE0004109AV
	7" PLC + HMI	PE0004100AV
	10.1" PLC + HMI	PE0004101AV
	Expansion Adapter	PE0004102AV
	Analog Expansion Module	PE0004103AV
	Digital Input Only Expansion Module	PE0004104AV
	Digital Input and Output Expansion Module	PE0004105AV

Troubleshooting Guide

Issue	Possible Cause	Corrective Action
No power	AC Power not available to the alarm panel	Connect AC power to the alarm panel power supply
	Blown fuse at the building electrical panel	Check the building's primary electrical panel and make sure the circuit breaker is switched to ON
	Alarm panel fuse lever in the OFF position	Switch the alarm panel fuse lever to the ON position
No audible alarm	Loose wire connection	With the alarm panel circuit breaker in the OFF position, make sure the wires are properly connected to the horn
	Alarm is in Maintenance Mode	Either wait 15 minutes for Maintenance Mode to automatically turn off, or go into settings and turn off Maintenance Mode
	Faulty horn	Replace horn (see replacement part list for part number)
Screen is not functioning	Faulty power supply	Replace power supply
	Wiring harness disconnected	Make sure the wiring harness from the power supply and terminal blocks are properly installed in the back of the PLC
	Alarm panel fuse lever in the OFF position	Switch the alarm panel fuse lever to the ON position
	AC power wiring is not properly connected	Make sure AC wiring is properly installed in the alarm panel power supply terminals
	HMI/PLC is faulty	Replace HMI/PLC. Contact Powerex Technical Service for additional assistance
"MISSING" alarm on Area gas badge	Sensor wires not connected	Make sure sensor wires are properly installed in the assigned terminal blocks
	Faulty sensor	Replace sensor (see replacement part list for part number)
Master alarm signals not displaying	Yellow "SAVE ALARM CONDITIONS" not pressed after entering alarm conditions	Press "SAVE ALARM CONDITIONS" after entering alarm conditions
Area gas display pressure reading not matching gauge on pipeline	Faulty gauge on pipeline	Check gauge on pipeline, replace if faulty
	Sensor out of calibration	Adjust the sensor offset using the "TRANSDUCER SETTINGS" function in the settings menu. Replace sensor if necessary (see replacement part list for part number)

Specifications

Operating temperature range: -4°F to 131°F

Storage temperature range: -22°F to 158°F

AC input: 120-240 VAC at 50/60 Hz

DC output: Dry Contacts capable of 30 VDC or 120 VAC max output

Input fuse: 2 Amp

Power consumption: 30 W Maximum

Pressure measurement accuracy: All positive pressure transducers: 0-200 psi $\pm 0.5\%$ at full scale

All vacuum transducers: 0-30 inHg $\pm 0.5\%$ at full scale

Dimensions (Width X Height X Depth)

Rough-in box – small: 12.4" X 10.4" X 4"

Rough-in box – large: 12.8" X 13.7" X 4"

Front panel – Small: 14" X 11.8"

Front Panel – Large: 14" X 15.4"

Transducers: 1.18" Diameter X 2.03" tall (Does not include DISS fitting)

Appendix A. BACnet Object Names

BACnet Object Name	Object Name Description
Gas1 Disp	The displayed gas pressure for a gas badge.
Gas2 Disp	
Gas3 Disp	
Gas4 Disp	
Gas5 Disp	
Gas6 Disp	
Gas7 Disp	
Gas8 Disp	
G1HiSpSet	The gas high pressure alarm setpoint for a gas badge.
G2HiSpSet	
G3HiSpSet	
G4HiSpSet	
G5HiSpSet	
G6HiSpSet	
G7HiSpSet	
G8HiSpSet	
G1LoSpSet	The gas low pressure alarm setpoint for a gas badge.
G2LoSpSet	
G3LoSpSet	
G4LoSpSet	
G5LoSpSet	
G6LoSpSet	
G7LoSpSet	
G8LoSpSet	
G1Mismatch	Gas Mismatch Alarm Status for a setup gas. A displayed value of 0= Normal, 1=Alarm.
G2Mismatch	
G3Mismatch	
G4Mismatch	
G5Mismatch	
G6Mismatch	
G7Mismatch	
G8Mismatch	
G1HiAlarm	Gas Badge High Alarm Status. A displayed value of 0=Normal, 1=Alarm.
G2HiAlarm	
G3HiAlarm	
G4HiAlarm	
G5HiAlarm	
G6HiAlarm	
G7HiAlarm	
G8HiAlarm	

BACnet Object Name	Object Name Description
G1HiAlarm	Gas Badge High Alarm Status. A displayed value of 0=Normal, 1=Alarm.
G2HiAlarm	
G3HiAlarm	
G4HiAlarm	
G5HiAlarm	
G6HiAlarm	
G7HiAlarm	
G8HiAlarm	
G1LoAlarm	Gas Badge Low Alarm Status. A displayed value of 0=Normal, 1=Alarm.
G2LoAlarm	
G3LoAlarm	
G4LoAlarm	
G5LoAlarm	
G6LoAlarm	
G7LoAlarm	
G8LoAlarm	
G1Missing	Gas Transducer Missing Alarm Status. A displayed value of 0=Normal, 1=Alarm.
G2Missing	
G3Missing	
G4Missing	
G5Missing	
G6Missing	
G7Missing	
G8Missing	
B#R#Alarm	“Master Alarm input alarm status. A displayed value of 0=Normal, 1=Alarm. B# = Master Badge # R# = Row # within a Master Alarm Badge Ex: B1R2 = The 1st Master Alarm badge has an alarm for input that was setup for the 2nd row. (Note: For badges 10, 11, and 12 ‘Alarm’ will show up as ‘Alar’ in the BACnet object name due to spacing limits.)”
BattAlarm	“PLC/HMI battery alarm status. A displayed value of 0=Normal, 1=Alarm. (Note: To maintained saved settings, change the battery while the HMI/PLC is still powered by 24VDC power.)”
Gen Fault	General Fault status. A displayed value of 0=Normal, 1=Alarm.

Powerex Limited Warranty

Warranty and Remedies.

(a) Standard Period of Warranty – Parts and Labor. Powerex warrants and represents all Products shall be free from Defects for the first twenty-four (24) months from the date of shipment by Powerex. During such warranty period, Powerex shall be fully liable for all Defects in the Products (the “Product Defects”), i.e., all costs of repair or replacement, which may include “in and out” charges, so long as the Products are located in the United States or Canada, and the Products are reasonably located and accessible by service personnel for removal. “In and out” charges include the costs of removing a Product from buyer’s equipment for repair or replacement.

(b) Additional Period of Warranty – Parts Only (No Labor). In addition to the above, Powerex warrants the products described herein shall be free of Defects for a period of sixty (60) months from the date of shipment by Powerex, with the exception of any components which are recommended to be replaced in less than sixty months in our Installation/Operation manuals. Within said period Powerex will repair or replace any part or component which is proven to be defective in either material or workmanship. This warranty covers parts only. Labor is not included. This warranty is valid only when the product has been properly installed according to Powerex specifications, used in a normal manner and serviced according to factory recommendations. This warranty does not cover failures due to damage which occurs in shipment or failures which result from accidents, misuse, abuse, neglect, mishandling, alteration, misapplication or damage due to acts of nature.

(c) General. Powerex warrants each Powerex branded Pipeline Accessory (collectively “Products”, individually each a “Product”) to be free from defects in material and workmanship (“Defects”) at the date of shipment. EXCEPT AS SET FORTH BELOW, NO OTHER WARRANTY, WHETHER EXPRESS OR IMPLIED, INCLUDING ANY WARRANTY OF MERCHANTABILITY OR FITNESS FOR A PARTICULAR PURPOSE, SHALL EXIST IN CONNECTION WITH THE SALE OR USE OF SUCH PRODUCTS. TO THE EXTENT PERMITTED BY LAW, ANY AND ALL IMPLIED WARRANTIES ARE EXCLUDED. All warranty claims must be made in writing and delivered to Powerex in accordance with the procedures set forth on its website (www.powerexinc.com), or such claim shall be barred. Upon timely receipt of a warranty claim, Powerex shall inspect the Product claimed to have a Defect, and Powerex shall replace any Product which it determines to have had a Defect; provided, however, that Powerex may elect, upon return of the Product, to refund to buyer any part of the purchase price of such Products paid to Powerex. Freight for returning Products to Powerex for inspection or for shipping warranty parts shall be paid by buyer where permitted by applicable law. Powerex is not responsible for any import fees, taxes, duties, licenses or other fees imposed by any governmental authority upon the production, sale, shipment and/or use of Products covered hereunder. The warranties and remedies herein are the sole and exclusive remedy for any breach of warranty or for any other claim based on any Defect, or non-performance of the Products, whether based upon contract, warranty or negligence.

(d) Coverage. The warranty provided herein applies to Powerex pipeline products only.

(e) Exceptions. Notwithstanding anything to the contrary herein, Powerex shall have no warranty obligations with respect to Products:

- (i)** That have not been installed in accordance with Powerex’s written specifications and instructions;
- (ii)** That have not been maintained in accordance with Powerex’s written instructions;
- (iii)** That have been materially modified without the prior written approval of Powerex; or
- (iv)** That experience failures resulting from operation, either intentional or otherwise, in excess of rated capacities or in an otherwise improper manner.

The warranty provided herein shall not apply to: **(i)** any defects arising from corrosion, abrasion, use of insoluble lubricants, or negligent attendance to or faulty operation of the Products; **(ii)** ordinary wear and tear of the Products; or **(iii)** defects arising from abnormal conditions of temperature, dirt or corrosive matter; **(iv)** any OEM component which is shipped by Powerex with the original manufacturer’s warranty, which shall be the sole applicable warranty for such component.

Limitation of Liability. NOTWITHSTANDING ANYTHING TO THE CONTRARY HEREIN, TO THE EXTENT ALLOWABLE

UNDER APPLICABLE LAW, UNDER NO CIRCUMSTANCES SHALL POWEREX BE LIABLE FOR ANY INCIDENTAL, CONSEQUENTIAL, PUNITIVE, SPECULATIVE OR INDIRECT LOSSES OR DAMAGES WHATSOEVER ARISING OUT OF OR IN ANY WAY RELATED TO ANY OF THE PRODUCTS OR GOODS SOLD OR AGREED TO BE SOLD BY POWEREX TO BUYER. TO THE EXTENT ALLOWABLE UNDER APPLICABLE LAW, POWEREX'S LIABILITY IN ALL EVENTS IS LIMITED TO, AND SHALL NOT EXCEED, THE PURCHASE PRICE PAID. In the event of breach of any warranty hereunder, Powerex's sole and exclusive liability shall be at its option either to repair or to replace any defective product, or to accept return, transportation prepaid, of such product and refund the purchase price; in either case provided that written notice of such defect is given to Powerex within twenty-four (24) months from date of shipment to Buyer, that the product is found by Powerex to have been defective at the time of such shipment, that the product has been installed and/or operated in accordance with Powerex's instructions, that no repairs, alterations or replacements have been made by others without Powerex's written approval, and that Buyer notifies Powerex in writing within fifteen (15) days after the defect becomes apparent and promptly furnishes full particulars in connection therewith; and provided further that in no event shall the aggregate liability of Powerex in connection with breach of any warranty or warranties exceed the purchase price paid for the product purchased hereunder. Powerex may, at its option, require the return of any product, transportation and duties prepaid, to establish any claim of defect made by Buyer. Unless otherwise agreed in writing **(a)** Powerex will not accept and shall have no responsibility for products returned without its prior written consent, and **(b)** Powerex will not assume any expense or liability for repairs to products made outside of its plant by third parties. In the event Powerex elects to replace a defective product, costs of installation, labor, service, and all other costs to replace the product shall be the responsibility of Buyer.

Powerex shall not, except as set forth above, be otherwise liable to Buyer or to any person who shall purchase from Buyer, or use, any products supplied hereunder for damages of any kind, including, but not limited to, indirect, special or consequential damages or loss of production or loss of profits resulting from any cause whatsoever, including, but not limited to, any delay, act, error or omission of Powerex. Supplier's repair or replacement of any Product shall not extend the period of any warranty of any Product.

Warranty Disclaimer. Powerex has made a diligent effort to illustrate and describe the Products in its literature, including its Price Book, accurately; however, such illustrations and descriptions are for the sole purpose of identification, and do not express or imply a warranty that the Products are merchantable, or fit for a particular purpose, or that the Products will necessarily conform to the illustrations or descriptions.

Product Suitability. Many jurisdictions have codes and regulations governing sales, construction, installation, and/or use of Products for certain purposes, which may vary from those in neighboring areas. While Powerex attempts to assure that its Products comply with such codes, it cannot guarantee compliance, and cannot be responsible for how the product is installed or used. Before purchase and use of a Product, please review the Product applications, and national and local codes and regulations, and be sure that the Product, installation, and use will comply with them.

Claims. Any non-warranty claims pertaining to the Products must be filed with Powerex within (6) months of the invoice date, or they will not be honored. Prices, discounts, and terms are subject to change without notice or as stipulated in specific Product quotations. Powerex shall not be liable for any delay or failure arising out of acts of the public enemy, fire, flood, or any disaster, labor trouble, riot or disorder, delay in the supply of materials or any other cause, whether similar or dissimilar, beyond the control of Company. All shipments are carefully inspected and counted before leaving the factory. Please inspect carefully any receipt of Products noting any discrepancy or damage on the carrier's freight bill at the time of delivery. Discrepancies or damage which obviously occurred in transit are the carrier's responsibility and related claims should be made promptly directly to the carrier. Returned Products will not be accepted without prior written authorization by Powerex and deductions from invoices for shortage or damage claims will not be allowed. **UNLESS OTHERWISE AGREED TO IN WRITING, THE TERMS AND CONDITIONS CONTAINED IN THIS LIMITED WARRANTY WILL CONTROL IN ANY TRANSACTION WITH POWEREX.** Any different or conflicting terms as may appear on any order form now or later submitted by the buyer will not control. All orders are subject to acceptance by Powerex.