

FirstCall[™] Cylinder x Cylinder Medical Gas Manifold Operating & Maintenance Manual

Please read and save these instructions. Read carefully before attempting to assemble, install, operate or maintain the product described. Protect yourself and others by observing all safety information. Failure to comply with instructions could result in personal injury and/or property damage! Retain instructions for future reference.

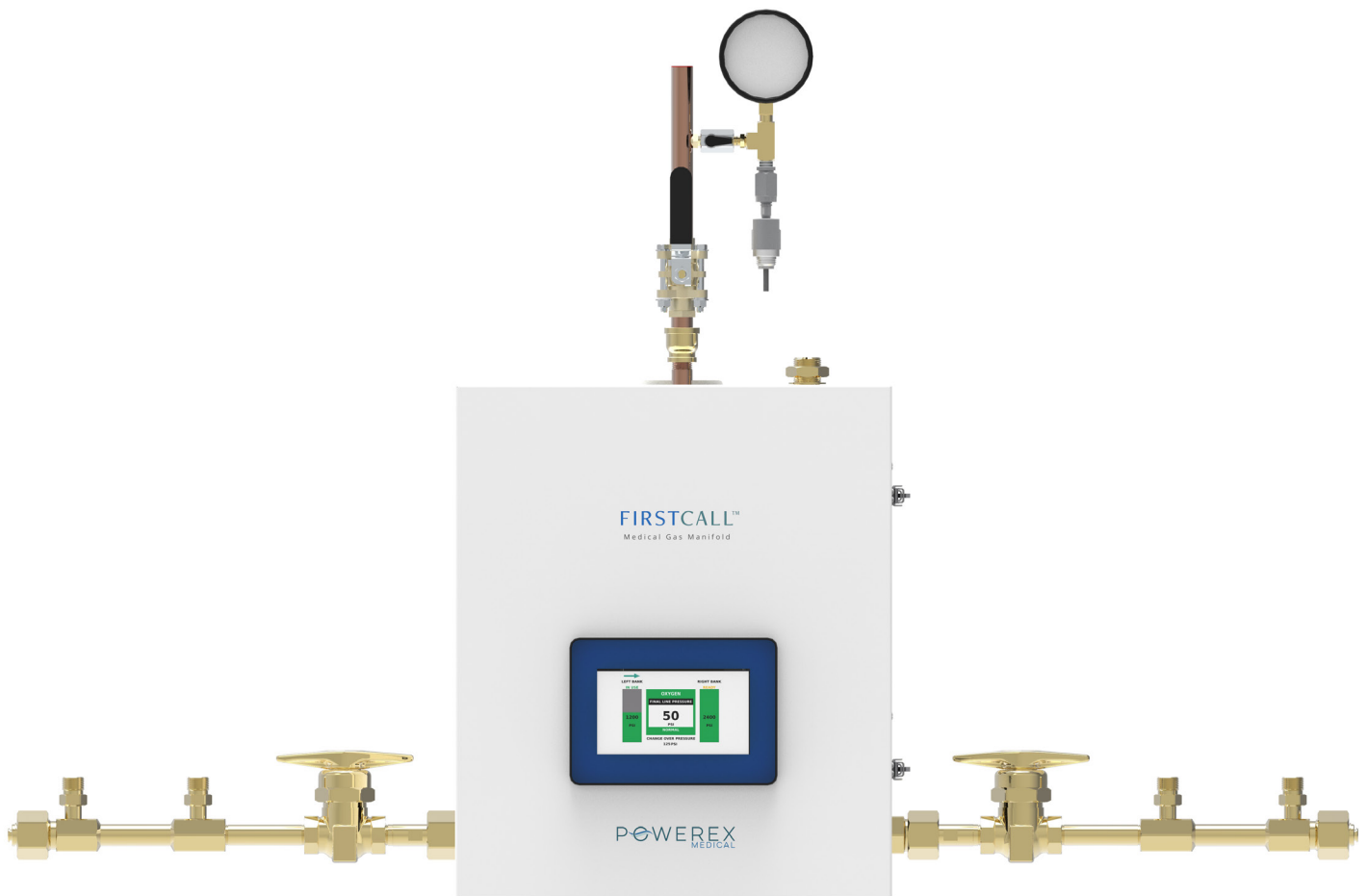

Table of Contents			
Responsibilities	4	Parts	16
Introduction	4	Specifications	17
Safety Guidelines	4	Dimensions	17
General Instructions/Location & Shelter	4	Weight	17
Product Line Overview	5	Flow Ratings	17
Configuration of Models	5	Pressure Settings	17
Cylinder x Cylinder	5	Operating Temperature Range	17
Installation	5	AC Input	17
Source Valve	5	DC Output	17
Manifold Cabinet Wall-mounting	6	Input Fuse	17
Header Installation	6	Power Consumption	17
Vent Line Plumbing	7	Manifold Regulator Repair Kit	17
Final Line Sensor & Gauge	7	Current Protection of Supply Circuit	17
Electrical	7	Appendix A. BACnet Object Names	18
NEMA 4 (optional)	8	Warranty	19
Pigtail & Cylinder Installation	8		
Power On	8		
Settings	9		
Login to Settings	9		
Alarm History	9		
Alarm Status	10		
Alarm Summary	10		
Gas Settings	10		
BACNet Settings	10		
Change Password	11		
Screen Setting Time & Date	11		
Maintenance Mode	11		
Startup & Verification of Changeover	11		
Final Line Pressure Adjustment	12		
Cylinder Replacement & Handling	12		
Maintenance Schedules	13		
Maintenance Mode	13		
Regulator Settings	13		
Line Regulator Switching	13		
Wiring Diagram	14		
Flow Diagram	15		

Responsibilities

Information contained in this manual pertains to the Powerex FirstCall™ medical gas manifold system. The manifold system will operate as described in this manual when operated and serviced in compliance with the instructions.

Installer Responsibilities

The manifold should be handled, installed, and tested per the recommended practice as described within this manual. Should any repair or replacement become necessary, contact Powerex for original equipment or replacement parts.

User Responsibilities

The manifold should be tested and examined periodically according to facility codes. Any parts which are found to be damaged, corroded, contaminated, etc. should be replaced.

Introduction

Safety Guidelines

Installation of the Powerex FirstCall™ Manifold involves installing the manifold cabinet, headers, and making the necessary conduit, plumbing and electrical connections. All installation and testing should be done in accordance with NFPA 99.

⚠ WARNING Electrical power intended for the manifold to be installed should be disconnected prior to installation.

⚠ WARNING This device should only be installed by qualified personnel. Installation should not be attempted by anyone not having general experience with the installation of devices of this nature.

⚠ CAUTION Failure to follow the following instructions can result in personal injury or property damage:

- Never permit oil, grease, or other combustible materials to come in contact with cylinders, manifold, and connections. Oil and grease may react with explosive force when ignited while in contact with some gases – particularly oxygen and nitrous oxide.
- Cylinder and master valves should always be opened very slowly. Heat of recompression may

ignite combustible materials creating an explosive force.

- Pigtails should never be kinked, twisted, or bent into a radius smaller than 3 inches. Mistreatment may cause the pigtail to burst.
- Do not apply heat. Oil and grease may react with explosive force when ignited while in contact with some gases – particularly oxygen and nitrous oxide.
- Cylinders should always be secured with racks, chains, or straps. Unrestrained cylinders may fall over and damage or break off the cylinder valve which may propel the cylinder from its current position.
- Oxygen manifolds and cylinders should be grounded. Static discharges and lightning may ignite materials in an oxygen atmosphere, creating a fire or explosive force.
- Welding should not be performed near nitrous oxide piping. Excessive heat may cause the gas to dissociate, creating an explosive force.
- Remove all protective caps prior to assembly. The protective cap may ignite due to heat of recompression in an oxygen system.

General Instructions/Location & Shelter

Manifolds should be installed in accordance with guidelines stated by the NFPA, CGA, OSHA, and all applicable local codes. Central supply systems and cylinders should not be placed in a location where the temperature will exceed 125°F (51.6°C) or fall below -20°F (-29°C). A manifold placed in an open location should be protected against weather conditions. During winter, protect the manifold from ice and snow. In summer, shade the manifold and cylinders from continuous exposure to direct sunlight. The flow capacity of nitrous oxide and carbon dioxide manifolds depend upon ambient temperature and the number of cylinders on line. Contact your gas supplier to determine the vaporization rate of Carbon Dioxide and Nitrous Oxide cylinders for the ambient temperature climate at the installation site. Leave all protective covers in place until their removal is required for installation. This precaution will keep moisture and debris from the piping interior.

Product Line Overview

The Powerex FirstCall™ fully-automatic medical gas manifold delivers an uninterrupted supply of medical gas to a facility from multiple high-pressure cylinders. The manifold is cleaned, tested, and prepared for the intended medical gas service. It is constructed in accordance with requirements of the latest edition of NFPA 99 and CGA. Features and benefits include:

- Designed and manufactured in the USA
- 5 year warranty on parts, 2 year warranty on labor
- Industry-leading flow capacity
- 7" high-resolution touchscreen HMI graphically displays bank pressure, primary/secondary bank status, final line pressure, changeover set point, alarm status
- Ethernet connectivity using BACnet over IP protocol to building management system – standard
- Controlled via next generation PLC technology
- Final line pressure transducer eliminates the need for an additional high/low pressure switch
- Robust changeover design using dome-loaded primary regulators controlled by dual solenoids
- Robust piston-style final line regulator
- Removable cabinet enclosure for improved service access
- Single point vent connection
- Maintenance mode
- Push-button bank changeover
- ¾" source valve included
- NEMA 4 enclosure optional
- Heaters optional for Nitrous Oxide and Carbon Dioxide
- Input power 110 VAC to 240 VAC, 50 to 60 Hz

PLC + HMI

Combination PLC+HMI monitors inputs from bank and final line transducers. The PLC controls bank changeover and generates alarm signals. Bank status and alarm status are displayed on high quality 7" LED HMI touchscreens. Preprogramed standard settings included with all standard medical gasses. Changeover pressure, alarm messages and descriptions are fully

customizable. Alarm and error history is recorded in Alarm Summary. The unit is capable of communicating with building monitoring system via Ethernet connection using BACnet over IP.

Configuration of Models

Cylinder x Cylinder

MFLD-CYL-NFPA-GG(-N4)-PSI

GG = Gas Type

O2 = Oxygen (55psig)

AIR = Medical Air (55psig)

N2O = Nitrous Oxide (55psig)

N2 = Nitrogen (180psig)

CO2 = Carbon Dioxide (55psig)

INST = Instrument Air (180psig)

HYP = Hyperbaric Oxygen (100psig)

N4 = NEMA 4 option

PSI = Dewar Pressure Indication

230 PSI

350 PSI

Ex. MFLD-CYL-NFPA-O2-230

MFLD-CYL-NFPA-N2O-N4-350

Installation

Source Valve

The P/N VP002700AV ½" M NPT x ¾" tube extension Source Valve is included with every FirstCall™ manifold. Install the source valve on the outlet of the manifold (located at the top center) prior to mounting the manifold cabinet.

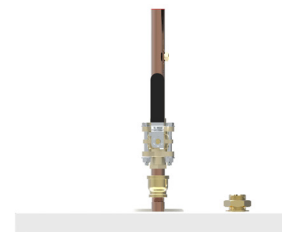

Manifold Cabinet Wall-mounting

To have clearance beneath the manifold for 55" tall "H" size cylinders, measure a distance of 58" from the floor and mark it on the wall. Using a level, draw a horizontal line at the mark. Place the mounting bracket on the wall, lining up the horizontal line with the bottom of the bracket, and mark the 4 mounting holes on the wall.

Use appropriate mounting hardware (not included) to fasten the mounting bracket to the wall.

Identify the slot on the back of the manifold near the top, and the corresponding tab on the top of the mounting bracket. Lift the manifold cabinet just over top of the mounting bracket and lower it so that the mounting bracket tab is inserted into the slot on the back of the cabinet.



Using the 4 5/16" bolts provided, tighten the manifold cabinet to the mounting bracket.

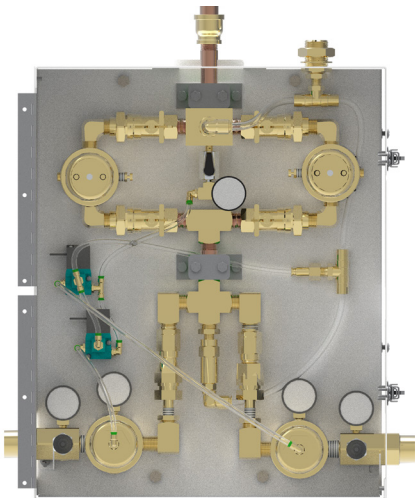

Header Installation

Powerex header assemblies, including Cylinder bank headers, Liquid x Liquid bank headers, and Emergency Reserve bank header (liquid only) are sold separately.

Attach the headers to the union on each side of the manifold control cabinet. Using a level, mark the placement of mounting brackets while keeping the header on a horizontal plane.

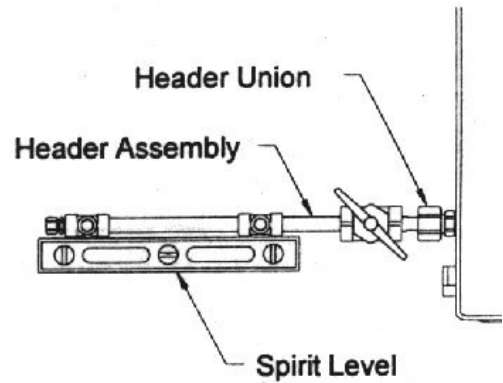

Remove the U-bolt assemblies from the header mounting brackets. Position the brackets so that the top of the bracket is aligned with the bottom of the headers and is centered between the cylinder connections. The end bracket should be placed as close to the last cylinder as possible to provide the most support and stability. Installation & Operating

Mark the mounting hole and install fasteners suitable for type of wall construction (fasteners not included)

Fit the U-bolt over the header piping and tighten the two mounting nuts.

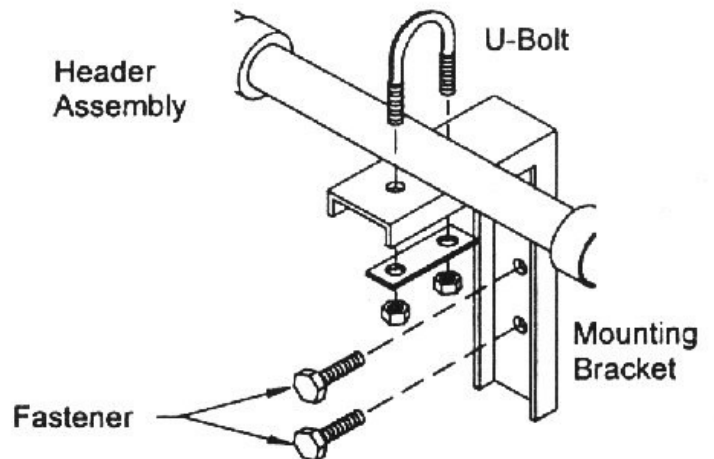

Vent Line Plumbing

The pressure relief valves are plumbed together inside of the Manifold and are connected at a single point on the top right of the manifold cabinet – the connection is a ½” FNPT thread.

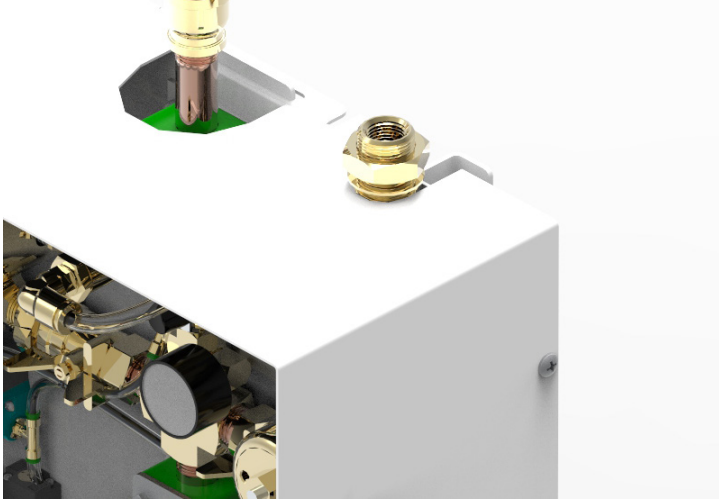

The vent line must be connected and plumbed by the contractor in a manner compliant with the latest version of NFPA 99

Final Line Sensor & Gauge

Remove the plug in the Source valve and install the final line sensor and gauge assembly (included).



Electrical

NOTE: Refer to page 15 for the wiring diagram.

Use the conduit hole located at the bottom right of the manifold cabinet to route conduit to supply 120 VAC to the power supply. 110 VAC to 240 VAC, 50 to 60 Hz single phase may be used with all units.



Power should be wired directly into the terminal blocks. The appropriate wiring locations are labeled L, N, and GND.

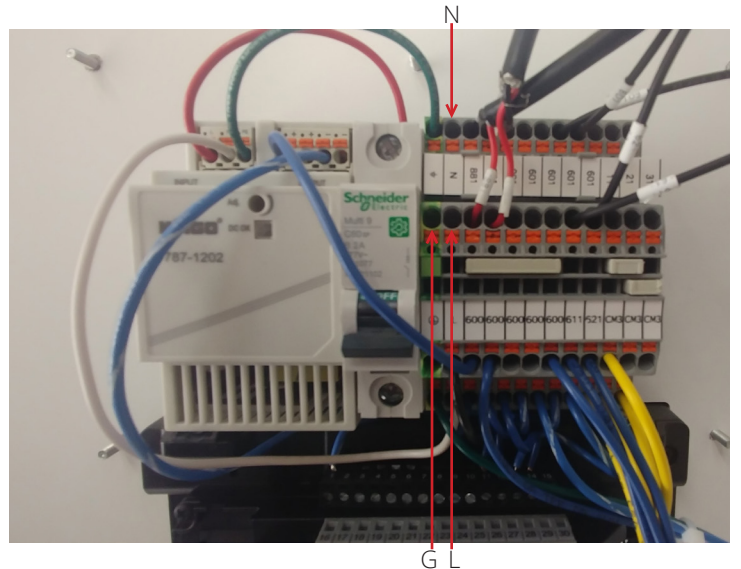

Connect the final line sensor wires to the correct location. There is a 12” length pair of low voltage wires with a lever nut on the end. Make sure the wire is routed in a way that the manifold cabinet door can open without stretching the wire.

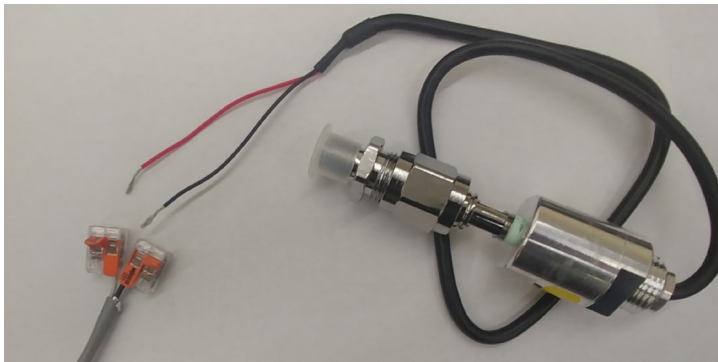

Final line sensor with wire and lever nut



Lever nut

NEMA 4 (optional)

If the optional NEMA 4 enclosure is installed, route the power and low voltage wires through the appropriate weatherproof grommet.

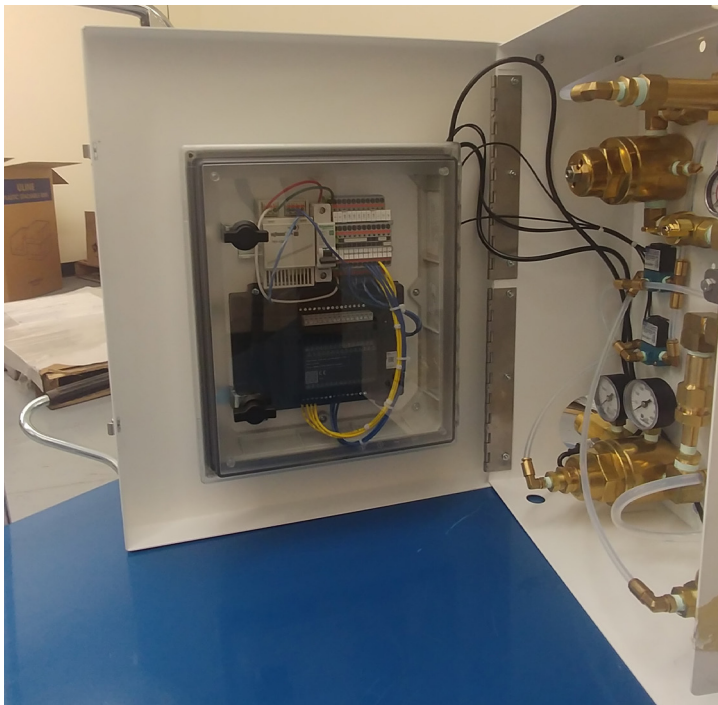

Pigtail & Cylinder Installation

The check valve outlet fittings on the manifold header bars are CGA gas-specific threads. Each of these fittings has an integral check valve. Make sure the 3-digit CGA number stamped on the outer perimeter of these fittings matches the CGA number stamped on the mating CGA fittings on the pigtails. Attach the pigtails to the check valve outlet fittings on the manifold header bars

Connect the pigtails to the check valve outlets on the manifold headers.



Check the master valves to be certain they are open (turn counter-clockwise to open). (Note: the master valve should always be left open. It is to be used only in the event of an emergency).

Check all cylinder and pigtail connections for leaks using an oxygen safe leak test solution (any bubbles forming around connections indicate leakage). The manifold has been tested for leaks at the factory, but the installer MUST check for leaks at all connections made during installation.

Power On

Turn on the 110-120 VAC power to the Manifold. Make sure the circuit breaker is switched to on near the power supply.

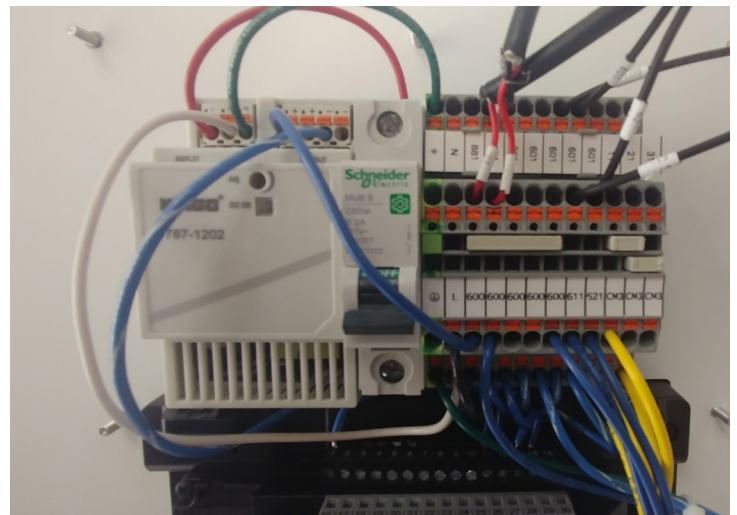

The Powerex FirstCall™ Manifold is pre-programmed for the appropriate gas and standard NFPA 99 pressure settings from the factory. However, some settings are able to be adjusted from the touchscreen HMI control panel.

Settings

Log in to Settings:

Press upper right part of screen for at least 3 seconds. Window pops up, hit the middle button for login.

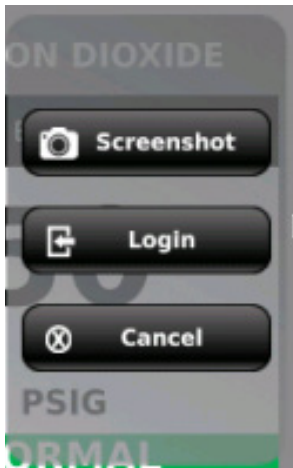

For user select "USER."



Default password is **Pass123** (case sensitive). This password can be changed in the settings screen.

Once the correct password is entered, the Manifold will now be in "Settings" mode. A "Settings" gear icon will appear at the bottom.

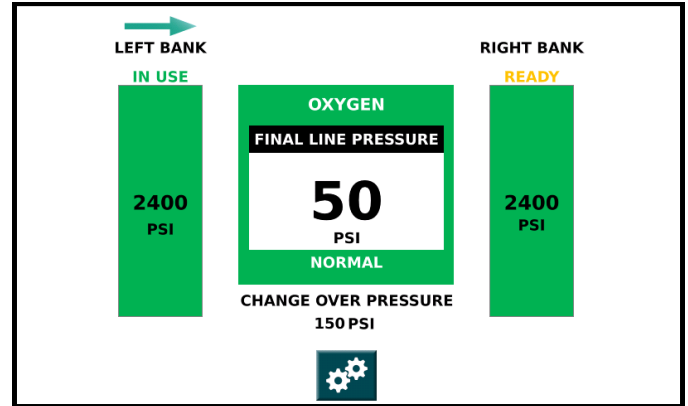

Press the "Settings" icon to get to the Settings Menu.

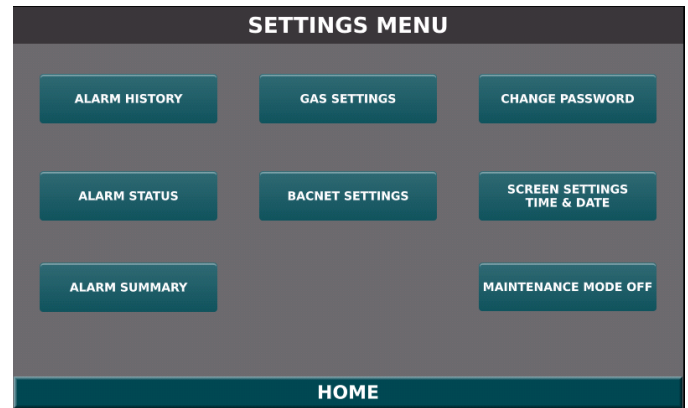

Alarm History

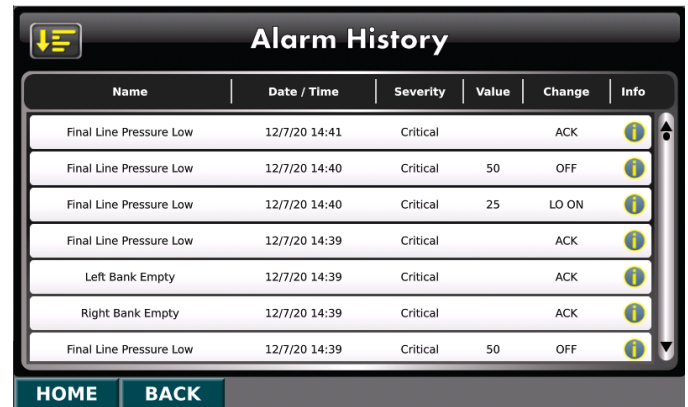

The Alarm History screen shows a record of all alarm events up to 32, including the specific alarm condition and the date and time of the alarm event.

This screen also has the ability to sort the alarm history list by a number of different criteria. The default sort is "Time". The alarm history list can be sorted differently by pressing the Alarm History Sort button in the upper left corner.

Alarm Status

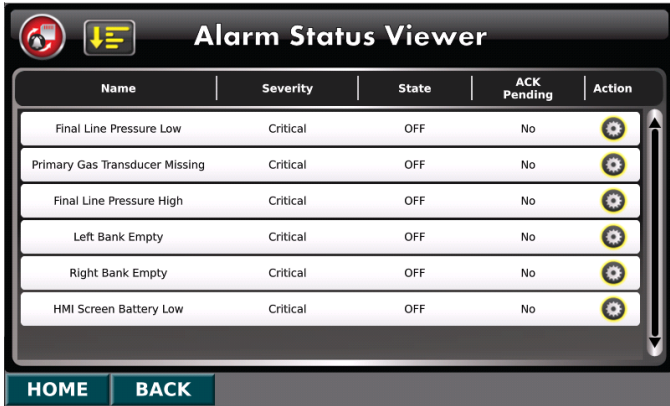

The Alarm Status screen shows a list of all possible alarm conditions for the maximum number of gases and input signals available in the Powerex FirstCall™ Alarm System.

The default alarms for each manifold are as follows:

- Main line pressure high
- Main line pressure low
- Changeover to secondary supply

Alarm Summary

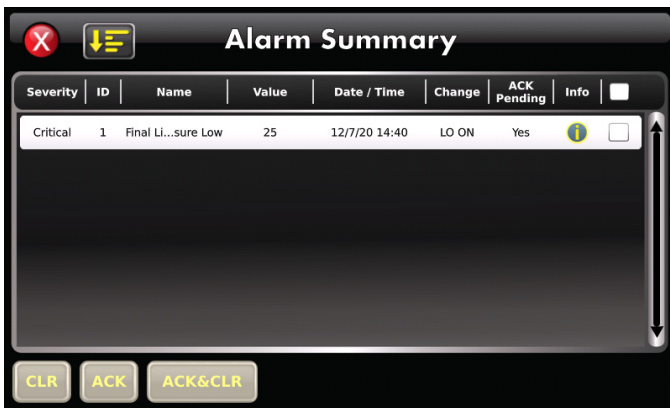

The Alarm Summary screen shows a list of all active alarm conditions.

This screen is also accessible from the red bar with the scrolling marquee at the bottom of the screen that pops up during an alarm event. Press the “list” icon, which is second from the left on the red bar.

Alarm conditions can be acknowledged and cleared on this screen. Further details are given in the “Alarm Event” section under “Operation.”

Gas Settings

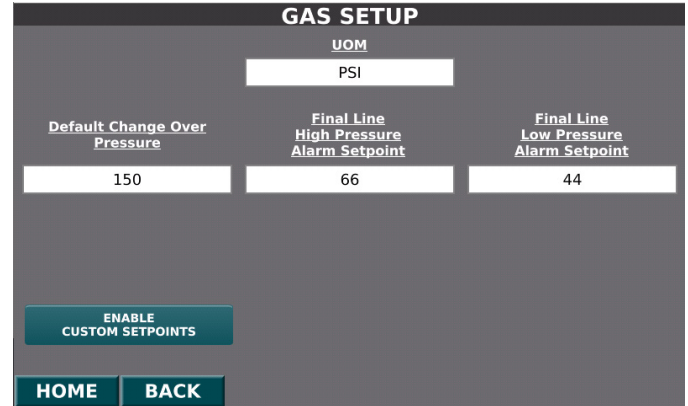

The Gas Settings screen is where you can adjust the changeover pressure and the high and low alarm setpoints.

To change these settings, first press the “ENABLE CUSTOM SETPOINTS” button in the lower left corner.

Press on the desired box that contains the value you want to change, and change the value in the keyboard that pops up. If the changeover pressure is changed, the new value will appear on the home screen underneath the gas badge.

NOTE: The gas type is not user-adjustable; UOM is adjustable.

BACnet

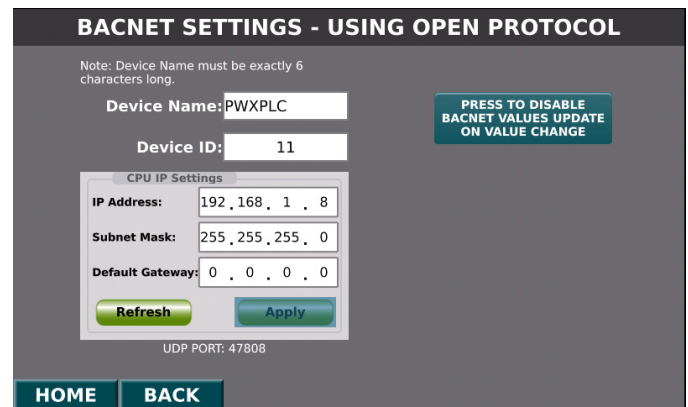

Enter desired device name – must be exactly 6 characters. Default name is always PWXPCL.

Enter desired Device ID number – any number between 0 and 255.

IP address for the PLC is already preloaded, but is able to be changed if required.

Subnet Mask is defaulted to 255, 255, 255, 0 – this can be changed if required.

Default Gateway is set at 0, 0, 0, 0 – this can be changed if required.

Press “Apply” to save settings, and the PLC will reboot after pressing “OK.”

Change Password



To change the password, press the “Change Password”, enter the old password, enter the desired new password, and confirm the desired new password.

Screen Settings

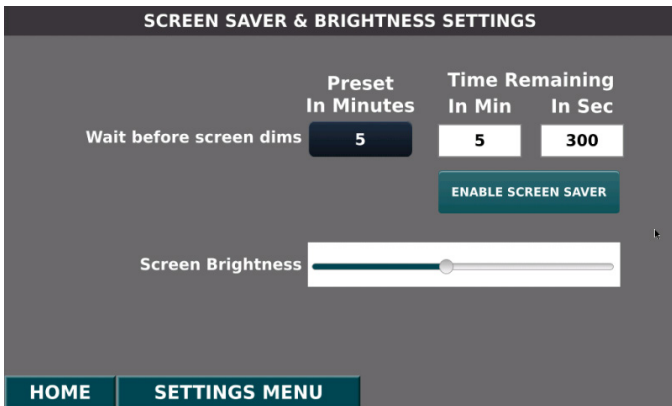

The Powerex FirstCall™ Manifold is factory-set with a 5 minute screen saver. The screen goes dark after 5 minutes, and reactivates if there is an alarm or the screen is touched. This time limit can be changed. The boxes to the right show the time remaining until the screen saver is enabled.

To disable the screen saver, press the “DISABLE SCREEN SAVER” button.

Screen brightness is set to 50% from the factory. This can be changed higher or lower depending on preference.

To maximize the lifespan of the screen, Powerex advises that the screen saver remain enabled and the default screen brightness be no higher than 50%.

Maintenance Mode (image toggled)

When Maintenance Mode is toggled, the manifold will not generate an alarm during a normal alarm event. This enables a technician to perform maintenance without setting off an alarm signal.

Maintenance mode automatically toggles back to normal after 15 minutes. A timer is displayed right below the button.

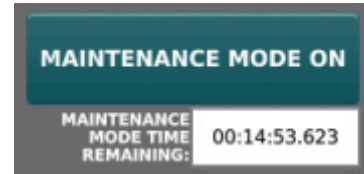

On the main screen, a yellow bar that reads “IN MAINTENANCE MODE” displays on the top.

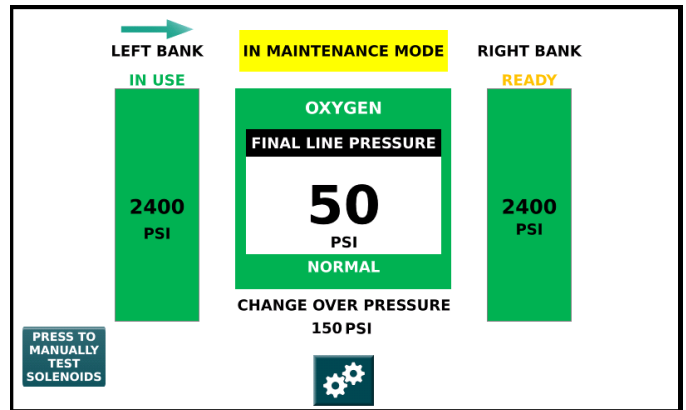

Startup & Verification of Changeover

Power the manifold on. Verify on the screen that both banks read EMPTY.

SLOWLY open one cylinder valve on the left bank. The left bank pressure gauge inside the cabinet and the graphical display on the screen should show the full pressure of the cylinder. It should read “IN USE” with an arrow over top of the left bank cylinder display.

SLOWLY open one cylinder valve on the right bank. The right bank pressure gauge inside the cabinet and the graphical display on the screen should show the full pressure of the cylinder. It should read “READY” over top of the left bank cylinder display.

Turn off all open cylinder valves on the left bank. Using the bleed valve on the left final line regulator, create a slight flow of gas. The left bank pressure should fall and the PLC will automatically switch over to the right bank. Delivery pressure remains constant. Left bank will show EMPTY in red and the Changeover to Secondary Supply alarm should activate on the Master Alarm and on the home screen.

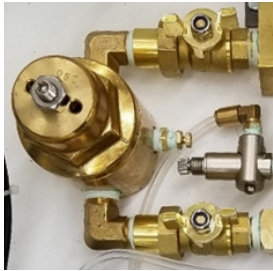

“ENERGIZE RIGHT SOLENOID” will appear underneath each cylinder graphic.

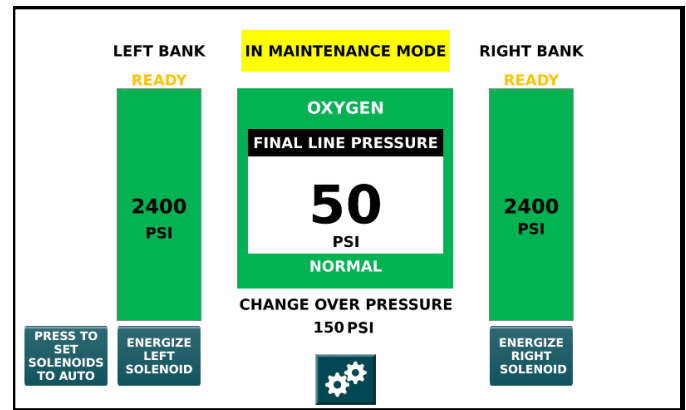
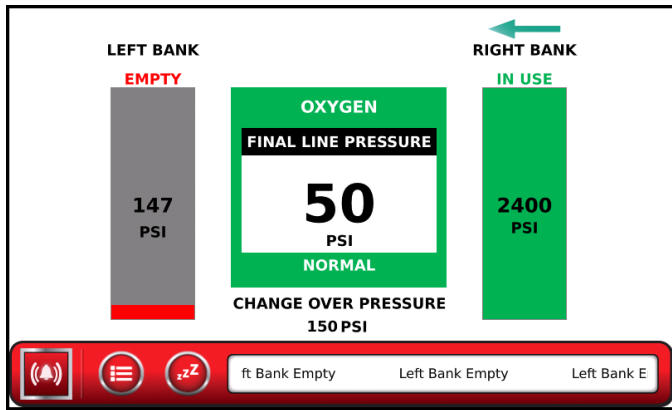

Close the bleed valve on the left final line regulator and SLOWLY reopen the cylinders on the left bank. The left bank pressure gauge and graphical display should return to full pressure. The left bank will now show “READY” above the cylinder graphic. The Changeover to Secondary Supply alarm will stop.

Repeat the last two steps to simulate an empty right bank.

The active bank is able to be adjusted from the HMI screen

Log in to the Settings Menu and toggle Maintenance Mode.

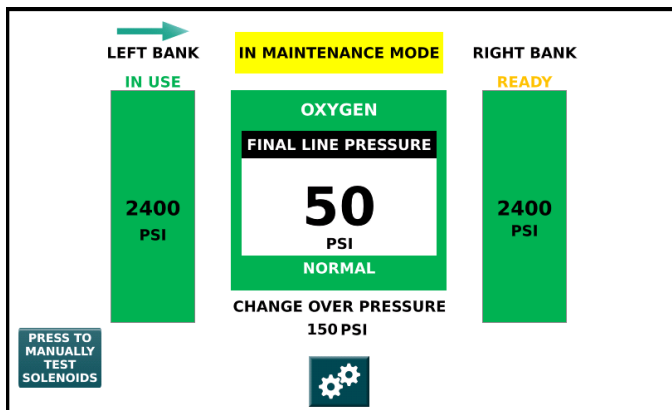

A button will appear on the lower left, “PRESS TO MANUALLY TEST SOLENOIDS”. Press this button and 2 new buttons, “ENERGIZE LEFT SOLENOID” and

Pressing these buttons will toggle the “IN USE” status to that bank. To switch over to the right bank, press the “ENERGIZE RIGHT SOLENOID” button. To switch to the left bank, press the “ENERGIZE LEFT SOLENOID” button.

Final Line Pressure Adjustment

The final line pressure may be adjusted by adjusting the spring tension on the line regulators by adjusting the tightness of the hex nut on top.

Tightening the nut will increase the pressure, loosening the nut will decrease the pressure. The line pressure setting may be monitored on the pressure gauge at the top of the manifold. To get the most accurate reading of the regulator setting there needs to be some flow through the regulator. The bleed valves allow adequate flow.

NOTE: Set points for the line pressure alarm will still need to be adjusted.

Cylinder Replacement & Handling

Close all cylinder valves on the depleted bank.

SLOWLY loosen and remove the pigtail connection from the depleted cylinders.

Remove depleted cylinders and replace protective caps.

Place and secure full cylinders into position using chains, belts or cylinder stands.

Remove protective cylinder caps from full replacement cylinders. With the valve outlet pointed away from all people in the area, slowly open each cylinder valve slightly for a split second to blow out any dirt or contaminants that may have become lodged into the

cylinder valve.

Connect pigtails to cylinder valves and tighten with wrench.

SLOWLY turn each cylinder valve until each cylinder is fully on.

Leak test the connections using an oxygen approved leak test solution.

Observe the following conditions: The red (Empty) LED is extinguished and the yellow (Ready) LED is illuminated and the secondary in use alarm is cancelled.

The manifold supply bank is now replenished and automatically placed in “reserve”.

Check for leaks semi-annually in all threaded fittings, including pigtail connection to header, header union to manifold, and high pressure relief valve.

Alarm set points, proper operation of changeover, header shutoff valves should all be verified and/or tested annually.

Pigtails are to be replaced every 5 years after date of startup.

Maintenance Schedules

Maintenance mode

Toggling the Maintenance Mode button will allow testing and service to be performed on the manifold without triggering alarm sent to the master panel. Maintenance mode is automatically turned off after 15 minutes. A timer is shown near the button once it's activated. On the main screen, a yellow bar that reads “IN MAINTENANCE MODE” displays on the top.

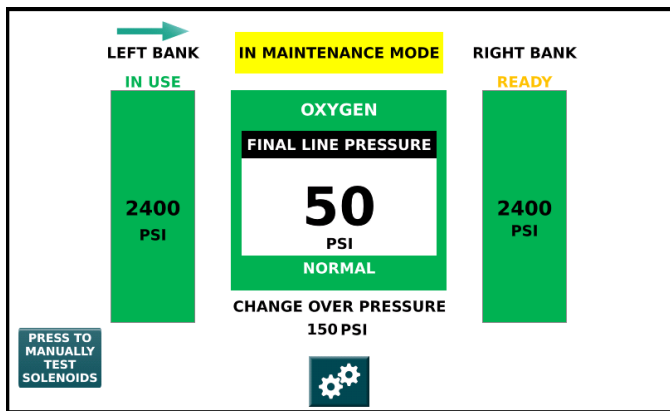

Regulator settings

Once a year, check and verify regulator settings

Line Regulator Switching

The line regulators should be alternated every 3 to 6 months. Alternate the regulators by manually opening the valves directly upstream and downstream of alternate regulator, then manually shutting off the valves directly upstream and downstream of the current active regulator. A bleed valve is located on the side of each final line regulator to purge trapped gas.

Wiring Diagram

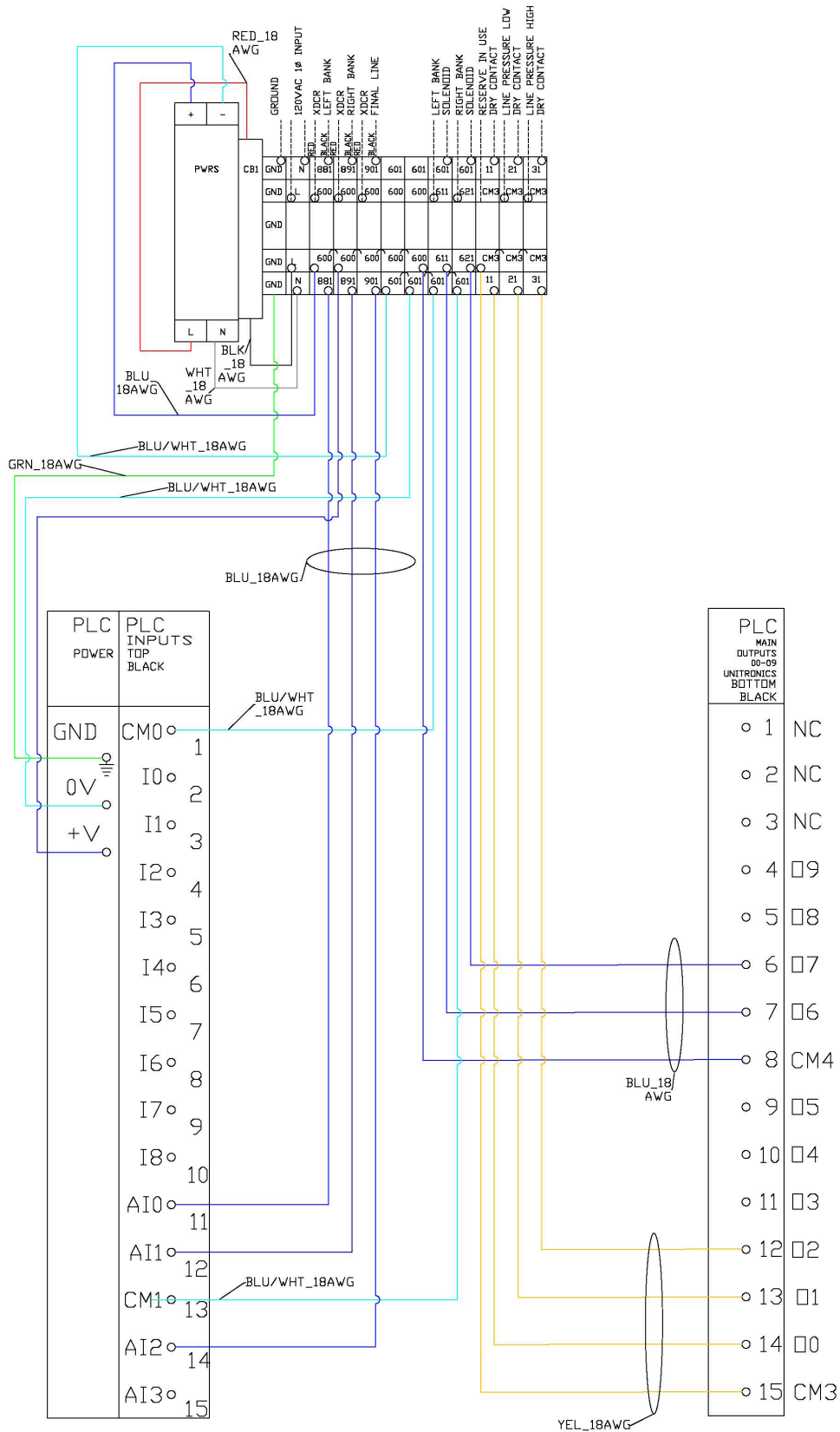

Flow Diagram

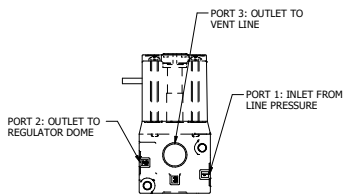
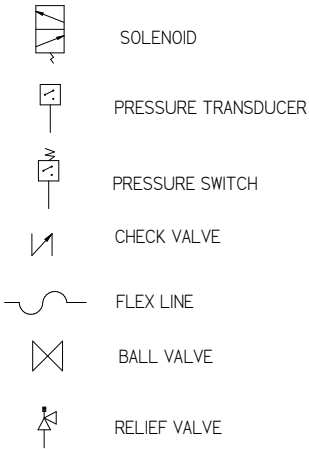

SOLENOID PLUMBING

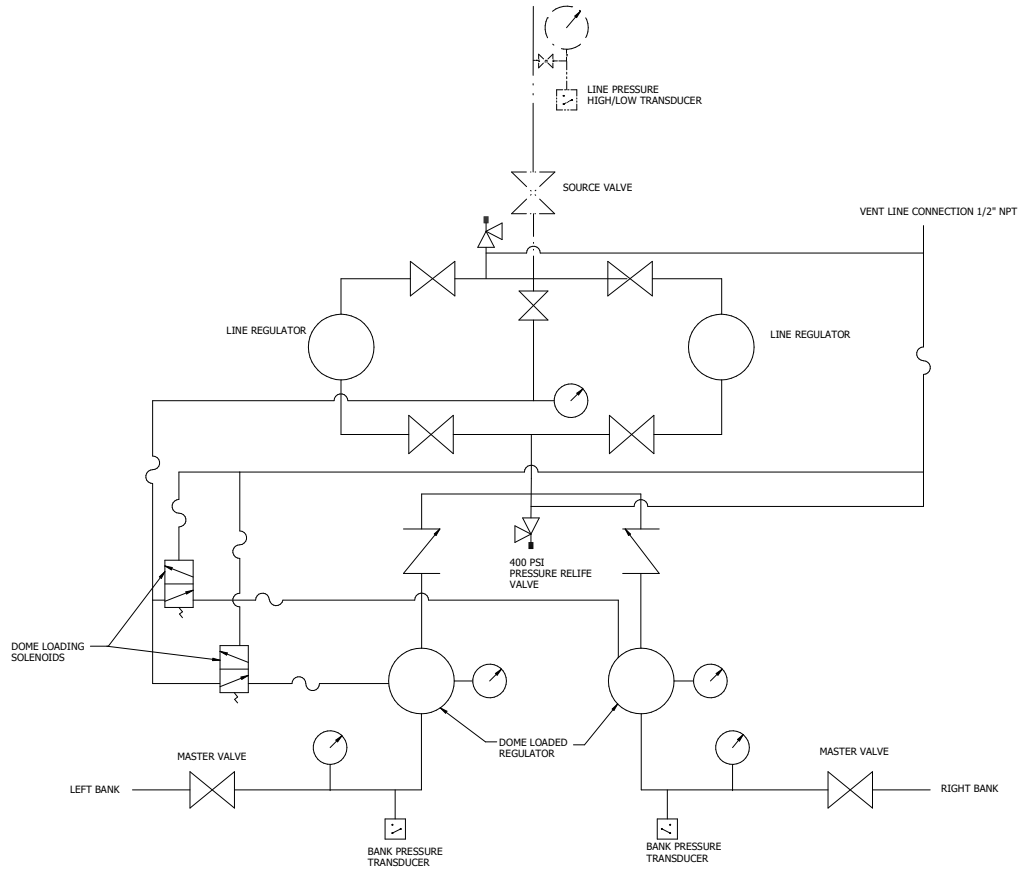

Parts

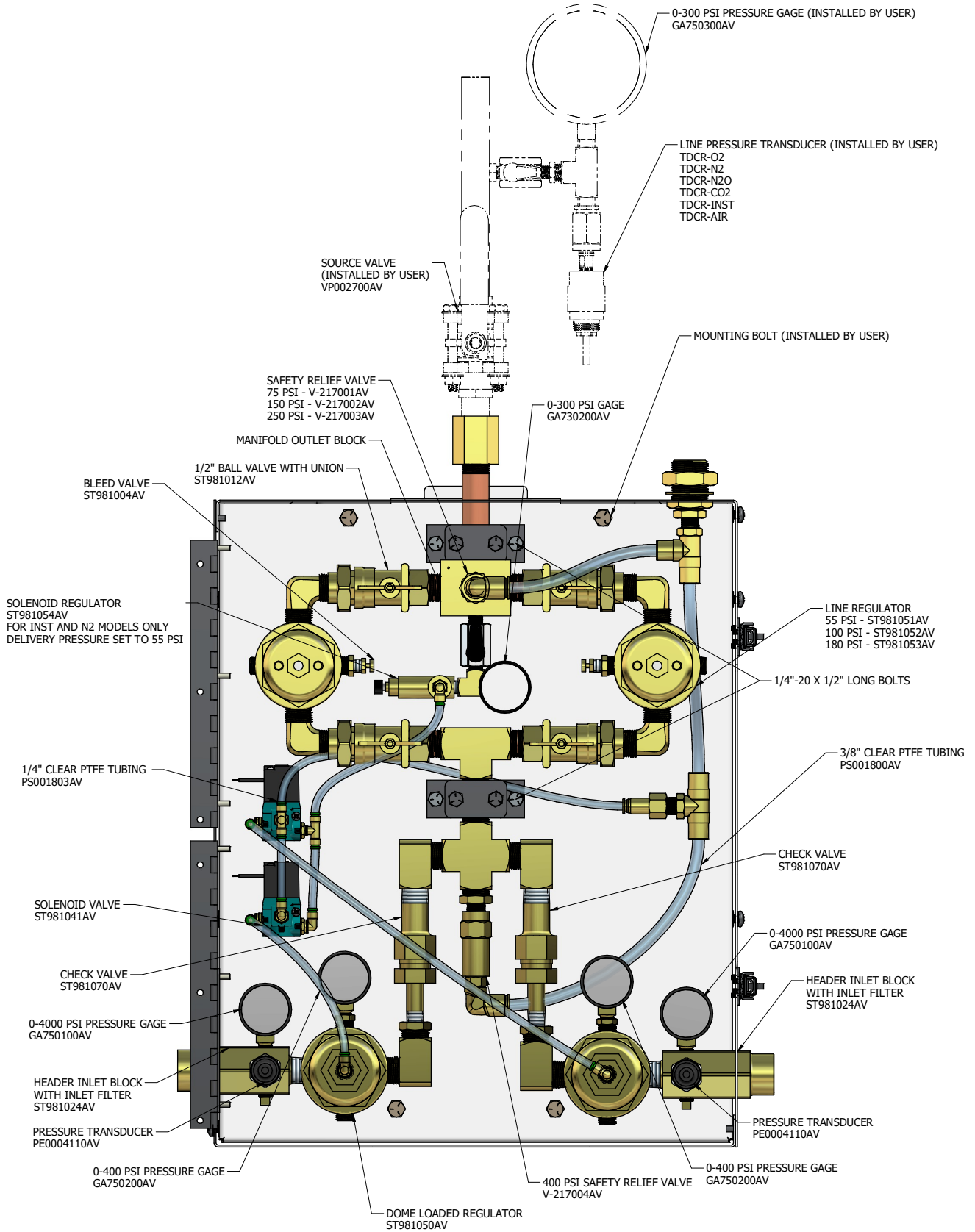

Specifications

Dimensions

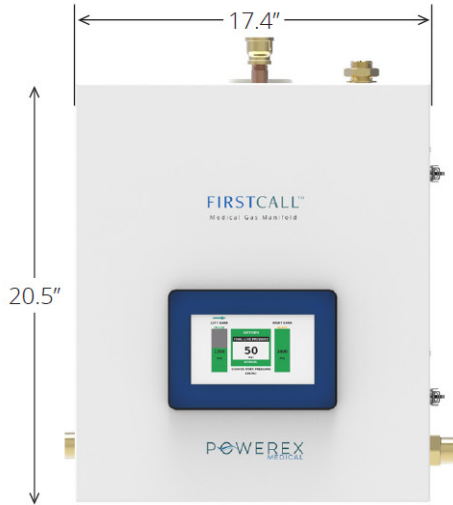

FRONT

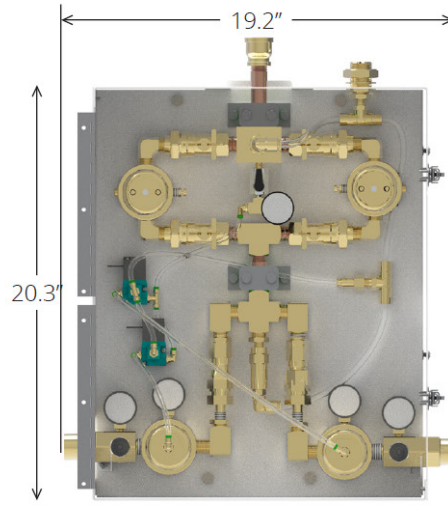

ROUGH-IN BOX



SIDE

Weight

75 lbs

Flow Ratings

Flow Characteristics at Min. Cylinder Pressure (Changeover)

Delivery Line Pressure (PSIG)	Min. Delivery Line Flow (SCFH)
55	3300
100	4620
180	5340

Pressure Settings

Parameter	Delivery Pressure (PSI)		
	55 PSI	100 PSI	180 PSI
Intermediate Pressure – Ready Bank	70 PSI	195 PSI	195 PSI
Dome Bias Pressure	55 PSI	55 PSI	55 PSI
Intermediate Pressure – In Use Bank	125 PSI	250 PSI	250 PSI
Intermediate Relief Valve	400 PSI	400 PSI	400 PSI
Line Regulator Relief Valve	75 PSI	150 PSI	250 PSI
Max. Inlet Pressure	3000 PSI	3000 PSI	3000 PSI

Operating Temperature Range

32° to 104°F (0° to 40°C)

AC Input

110 to 240 VAC

DC Output

24 VDC

Input Fuse

2 Amp

Power Consumption

31.2 Watt

Manifold Regulator Repair Kit

P/N ST981055AV

Current Protection of Supply Circuit

15 Amp Maximum

Appendix A. BACnet Object Names

BACnet Object Name	Object Name Description
FinalLPSI	The displayed pressure value for Final Line Pressure
LefTnkPSI	The displayed pressure value for the left tank
RihTnkPSI	The displayed pressure value for the right tank
ChangePSI	The tank change over pressure value
UOM Type	The unit of measured used in relation to displayed pressure values
FinLinHSP	The High Pressure alarm set point for Final Line Pressure
FinalLSP	The Low Pressure alarm set point for Final Line Pressure
FinalLoAl	Final Line Pressure High Pressure Alarm Status; 0=No Alarm, 1=Alarm
FinalHiAl	Final Line Pressure Low Pressure Alarm Status; 0=No Alarm, 1=Alarm
MissingTr	Final Line Pressure transducer missing alarm; 0=No Alarm, 1=Alarm
LeftEmpty	Left Tank Empty alarm; 0=No Alarm, 1=Alarm
RightEmpt	Right Tank Empty alarm; 0=No Alarm, 1=Alarm
LowBatrAL	"PLC/HMI battery alarm status; 0=Normal, 1=Alarm. (NOTE: To maintain saved settings, change the battery while the HMI/PLC is still powered by 24VDC power.)"
AlarmStat	General Fault status; 0=No Alarm, 1=Alarm

Powerex Limited Warranty

Warranty and Remedies.

(a) Standard Period of Warranty – Parts and Labor. Powerex warrants and represents all Products shall be free from Defects for the first twenty-four (24) months from the date of shipment by Powerex. During such warranty period, Powerex shall be fully liable for all Defects in the Products (the “Product Defects”), i.e., all costs of repair or replacement, which may include “in and out” charges, so long as the Products are located in the United States or Canada, and the Products are reasonably located and accessible by service personnel for removal. “In and out” charges include the costs of removing a Product from buyer’s equipment for repair or replacement.

(b) Additional Period of Warranty – Parts Only (No Labor). In addition to the above, Powerex warrants the products described herein shall be free of Defects for a period of sixty (60) months from the date of shipment by Powerex, with the exception of any components which are recommended to be replaced in less than sixty months in our Installation/Operation manuals. Within said period Powerex will repair or replace any part or component which is proven to be defective in either material or workmanship. This warranty covers parts only. Labor is not included. This warranty is valid only when the product has been properly installed according to Powerex specifications, used in a normal manner and serviced according to factory recommendations. This warranty does not cover failures due to damage which occurs in shipment or failures which result from accidents, misuse, abuse, neglect, mishandling, alteration, misapplication or damage due to acts of nature.

(c) General. Powerex warrants each Powerex branded Pipeline Accessory (collectively “Products”, individually each a “Product”) to be free from defects in material and workmanship (“Defects”) at the date of shipment. EXCEPT AS SET FORTH BELOW, NO OTHER WARRANTY, WHETHER EXPRESS OR IMPLIED, INCLUDING ANY WARRANTY OF MERCHANTABILITY OR FITNESS FOR A PARTICULAR PURPOSE, SHALL EXIST IN CONNECTION WITH THE SALE OR USE OF SUCH PRODUCTS. TO THE EXTENT PERMITTED BY LAW, ANY AND ALL IMPLIED WARRANTIES ARE EXCLUDED. All warranty claims must be made in writing and delivered to Powerex in accordance with the procedures set forth on its website (www.powerexinc.com), or such claim shall be barred. Upon timely receipt of a warranty claim, Powerex shall inspect the Product claimed to have a Defect, and Powerex shall replace any Product which it determines to have had a Defect; provided, however, that Powerex may elect, upon return of the Product, to refund to buyer any part of the purchase price of such Products paid to Powerex. Freight for returning Products to Powerex for inspection or for shipping warranty parts shall be paid by buyer where permitted by applicable law. Powerex is not responsible for any import fees, taxes, duties, licenses or other fees imposed by any governmental authority upon the production, sale, shipment and/or use of Products covered hereunder. The warranties and remedies herein are the sole and exclusive remedy for any breach of warranty or for any other claim based on any Defect, or non-performance of the Products, whether based upon contract, warranty or negligence.

(d) Coverage. The warranty provided herein applies to Powerex pipeline products only.

(e) Exceptions. Notwithstanding anything to the contrary herein, Powerex shall have no warranty obligations with respect to Products:

- (i)** That have not been installed in accordance with Powerex’s written specifications and instructions;
- (ii)** That have not been maintained in accordance with Powerex’s written instructions;
- (iii)** That have been materially modified without the prior written approval of Powerex; or
- (iv)** That experience failures resulting from operation, either intentional or otherwise, in excess of rated capacities or in an otherwise improper manner.

The warranty provided herein shall not apply to: **(i)** any defects arising from corrosion, abrasion, use of insoluble lubricants, or negligent attendance to or faulty operation of the Products; **(ii)** ordinary wear and tear of the Products; or **(iii)** defects arising from abnormal conditions of temperature, dirt or corrosive matter; **(iv)** any OEM component which is shipped by Powerex with the original manufacturer’s warranty, which shall be the sole applicable warranty for such component.

Limitation of Liability. NOTWITHSTANDING ANYTHING TO THE CONTRARY HEREIN, TO THE EXTENT ALLOWABLE

UNDER APPLICABLE LAW, UNDER NO CIRCUMSTANCES SHALL POWEREX BE LIABLE FOR ANY INCIDENTAL, CONSEQUENTIAL, PUNITIVE, SPECULATIVE OR INDIRECT LOSSES OR DAMAGES WHATSOEVER ARISING OUT OF OR IN ANY WAY RELATED TO ANY OF THE PRODUCTS OR GOODS SOLD OR AGREED TO BE SOLD BY POWEREX TO BUYER. TO THE EXTENT ALLOWABLE UNDER APPLICABLE LAW, POWEREX'S LIABILITY IN ALL EVENTS IS LIMITED TO, AND SHALL NOT EXCEED, THE PURCHASE PRICE PAID. In the event of breach of any warranty hereunder, Powerex's sole and exclusive liability shall be at its option either to repair or to replace any defective product, or to accept return, transportation prepaid, of such product and refund the purchase price; in either case provided that written notice of such defect is given to Powerex within twenty-four (24) months from date of shipment to Buyer, that the product is found by Powerex to have been defective at the time of such shipment, that the product has been installed and/or operated in accordance with Powerex's instructions, that no repairs, alterations or replacements have been made by others without Powerex's written approval, and that Buyer notifies Powerex in writing within fifteen (15) days after the defect becomes apparent and promptly furnishes full particulars in connection therewith; and provided further that in no event shall the aggregate liability of Powerex in connection with breach of any warranty or warranties exceed the purchase price paid for the product purchased hereunder. Powerex may, at its option, require the return of any product, transportation and duties prepaid, to establish any claim of defect made by Buyer. Unless otherwise agreed in writing **(a)** Powerex will not accept and shall have no responsibility for products returned without its prior written consent, and **(b)** Powerex will not assume any expense or liability for repairs to products made outside of its plant by third parties. In the event Powerex elects to replace a defective product, costs of installation, labor, service, and all other costs to replace the product shall be the responsibility of Buyer.

Powerex shall not, except as set forth above, be otherwise liable to Buyer or to any person who shall purchase from Buyer, or use, any products supplied hereunder for damages of any kind, including, but not limited to, indirect, special or consequential damages or loss of production or loss of profits resulting from any cause whatsoever, including, but not limited to, any delay, act, error or omission of Powerex. Supplier's repair or replacement of any Product shall not extend the period of any warranty of any Product.

Warranty Disclaimer. Powerex has made a diligent effort to illustrate and describe the Products in its literature, including its Price Book, accurately; however, such illustrations and descriptions are for the sole purpose of identification, and do not express or imply a warranty that the Products are merchantable, or fit for a particular purpose, or that the Products will necessarily conform to the illustrations or descriptions.

Product Suitability. Many jurisdictions have codes and regulations governing sales, construction, installation, and/or use of Products for certain purposes, which may vary from those in neighboring areas. While Powerex attempts to assure that its Products comply with such codes, it cannot guarantee compliance, and cannot be responsible for how the product is installed or used. Before purchase and use of a Product, please review the Product applications, and national and local codes and regulations, and be sure that the Product, installation, and use will comply with them.

Claims. Any non-warranty claims pertaining to the Products must be filed with Powerex within (6) months of the invoice date, or they will not be honored. Prices, discounts, and terms are subject to change without notice or as stipulated in specific Product quotations. Powerex shall not be liable for any delay or failure arising out of acts of the public enemy, fire, flood, or any disaster, labor trouble, riot or disorder, delay in the supply of materials or any other cause, whether similar or dissimilar, beyond the control of Company. All shipments are carefully inspected and counted before leaving the factory. Please inspect carefully any receipt of Products noting any discrepancy or damage on the carrier's freight bill at the time of delivery. Discrepancies or damage which obviously occurred in transit are the carrier's responsibility and related claims should be made promptly directly to the carrier. Returned Products will not be accepted without prior written authorization by Powerex and deductions from invoices for shortage or damage claims will not be allowed. **UNLESS OTHERWISE AGREED TO IN WRITING, THE TERMS AND CONDITIONS CONTAINED IN THIS LIMITED WARRANTY WILL CONTROL IN ANY TRANSACTION WITH POWEREX.** Any different or conflicting terms as may appear on any order form now or later submitted by the buyer will not control. All orders are subject to acceptance by Powerex.