

MVECQ0405xx1

MED VAC ENCLOSURE 4 HP QUADPLEX CLAW 200G TANK

REVISION NOTES		
DESCRIPTION	ECN	PR/NOR
RELEASE TO PRODUCTION	PXEC0558	XXXXXXXX

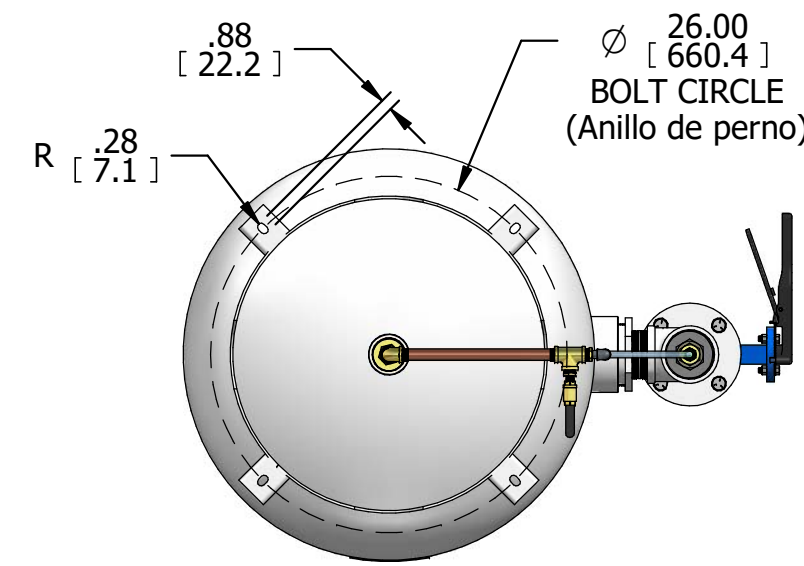

4X FLOOR MOUNTING SLOTS
(Ranuras de Montaje)

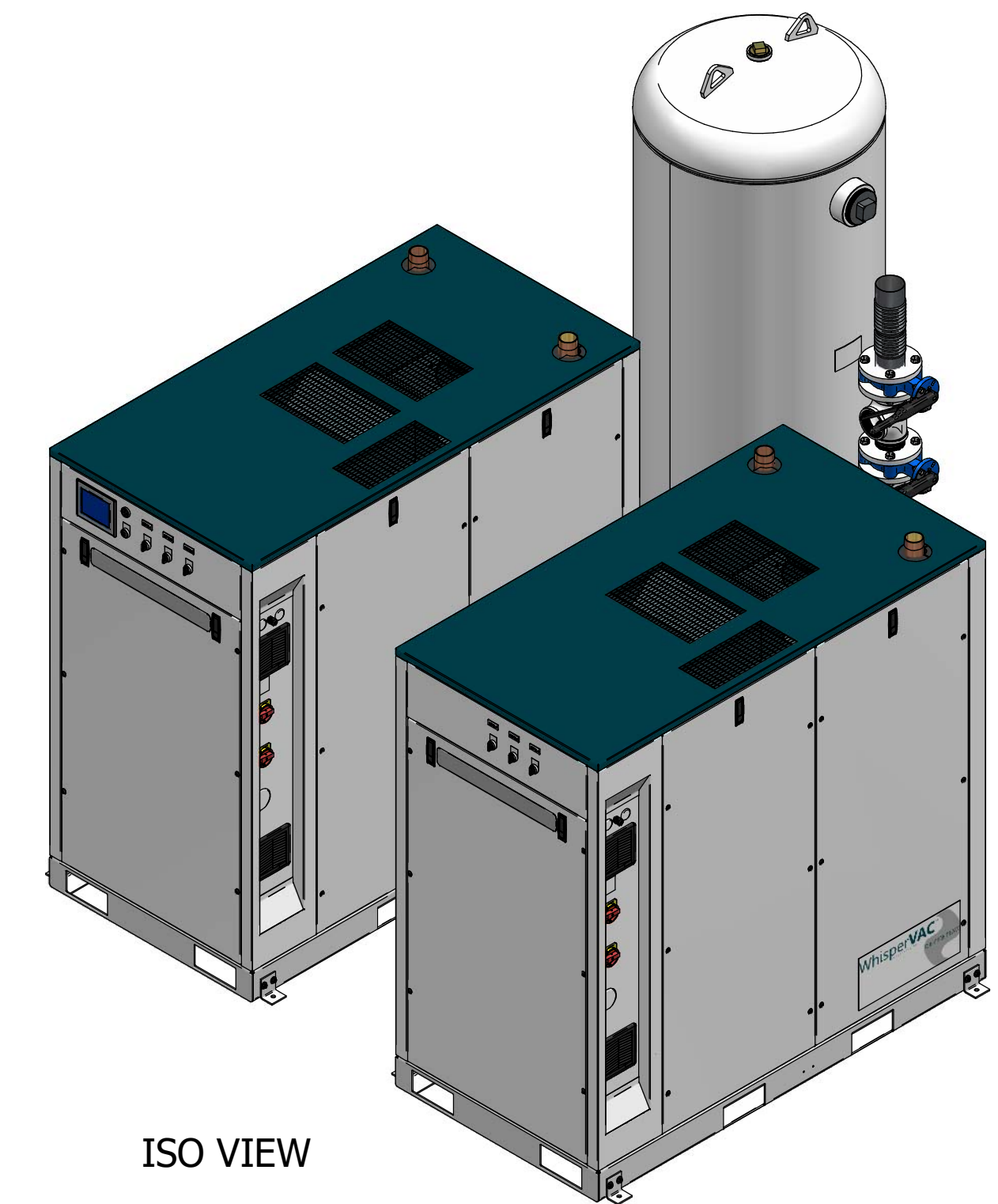
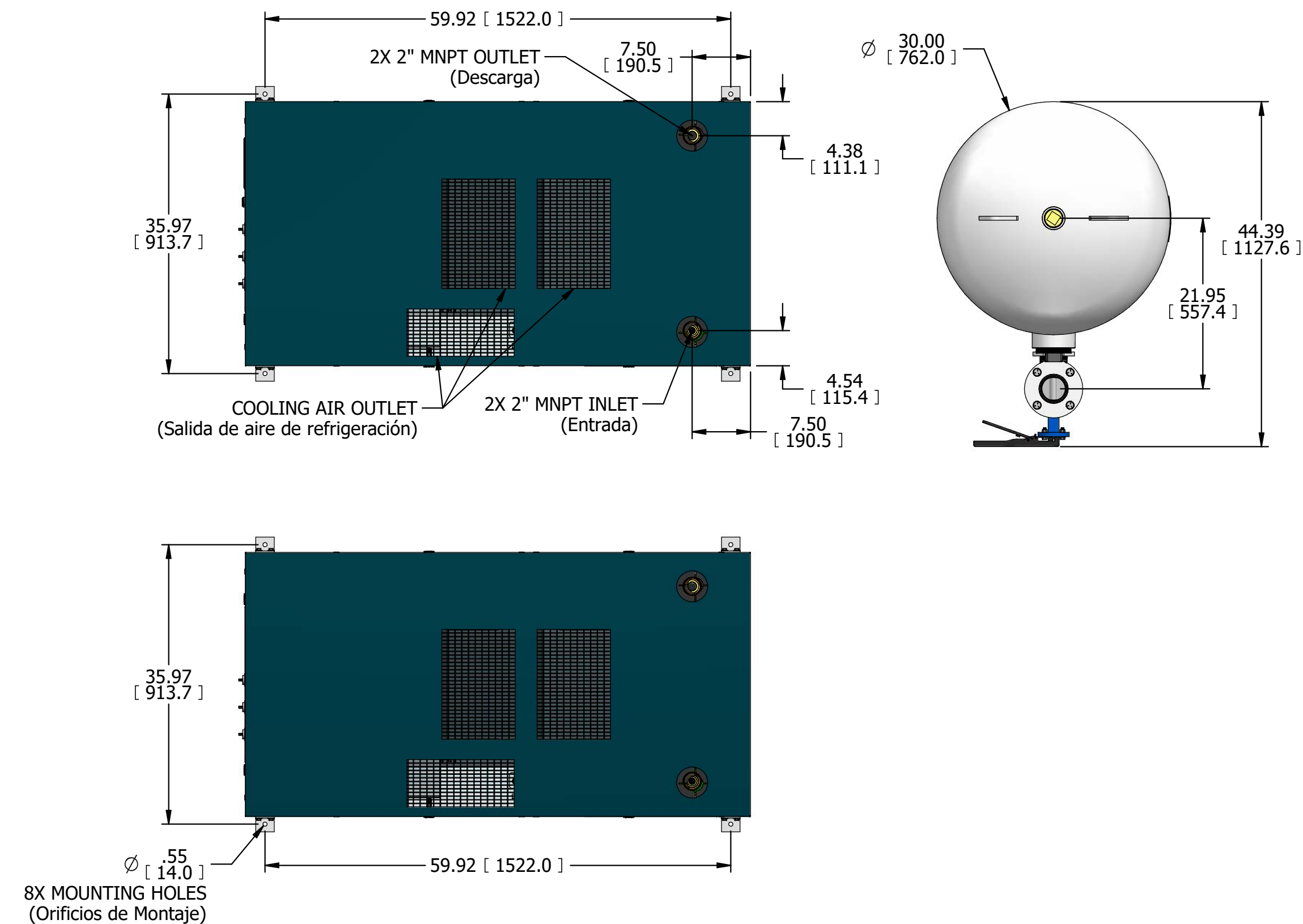

ISO VIEW

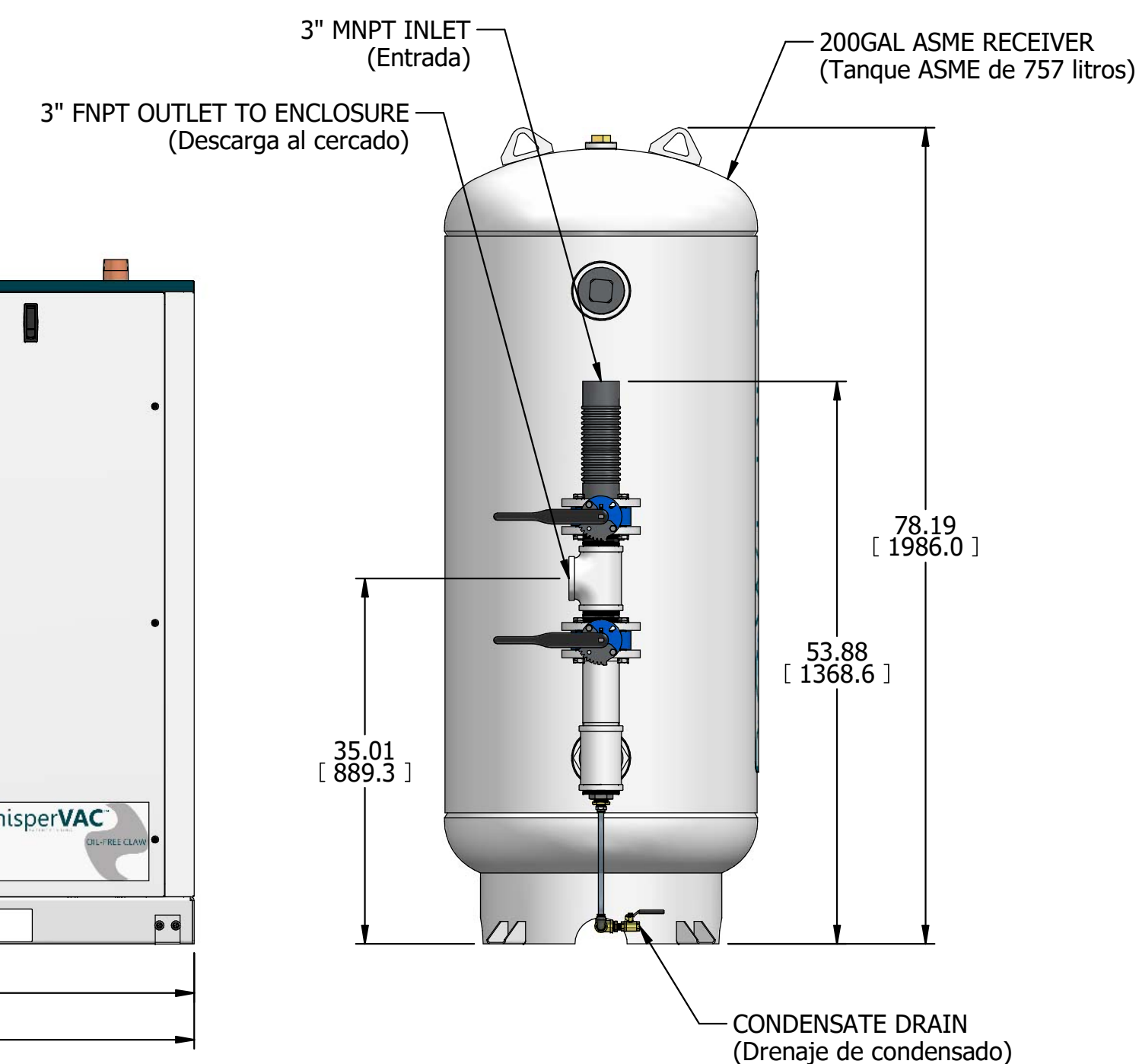
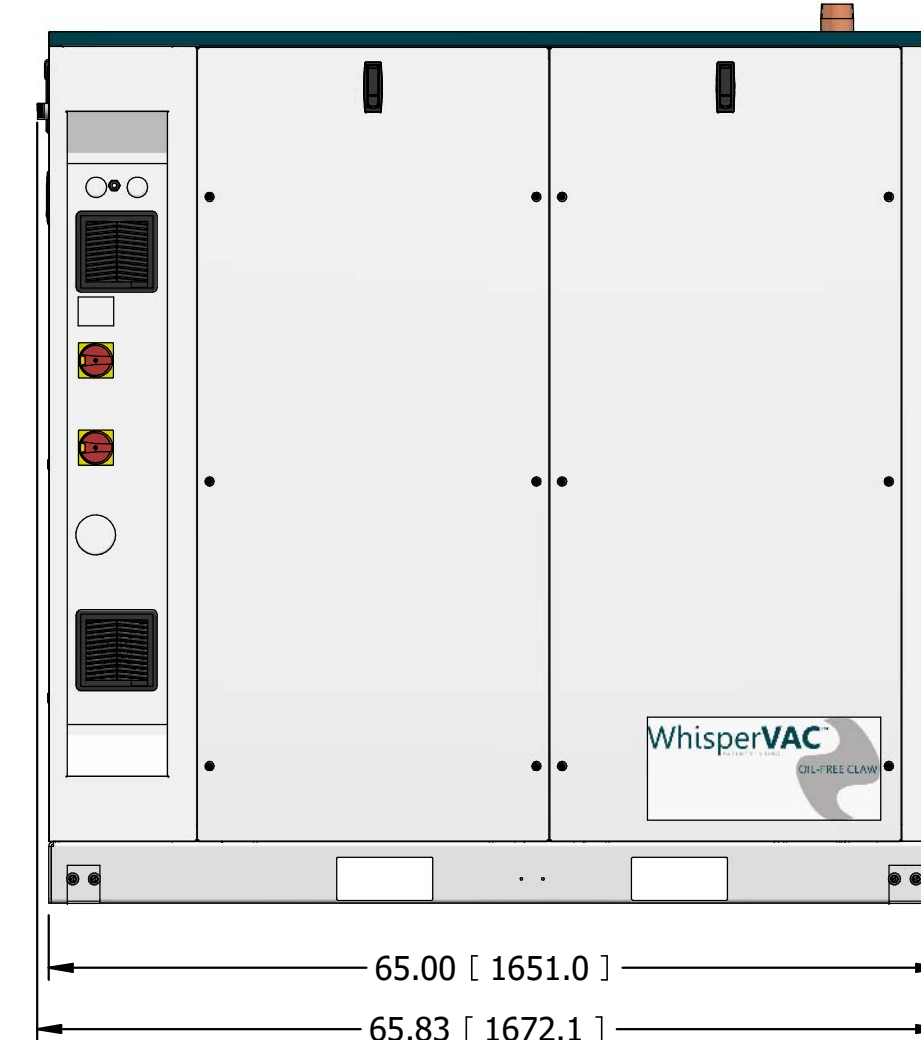
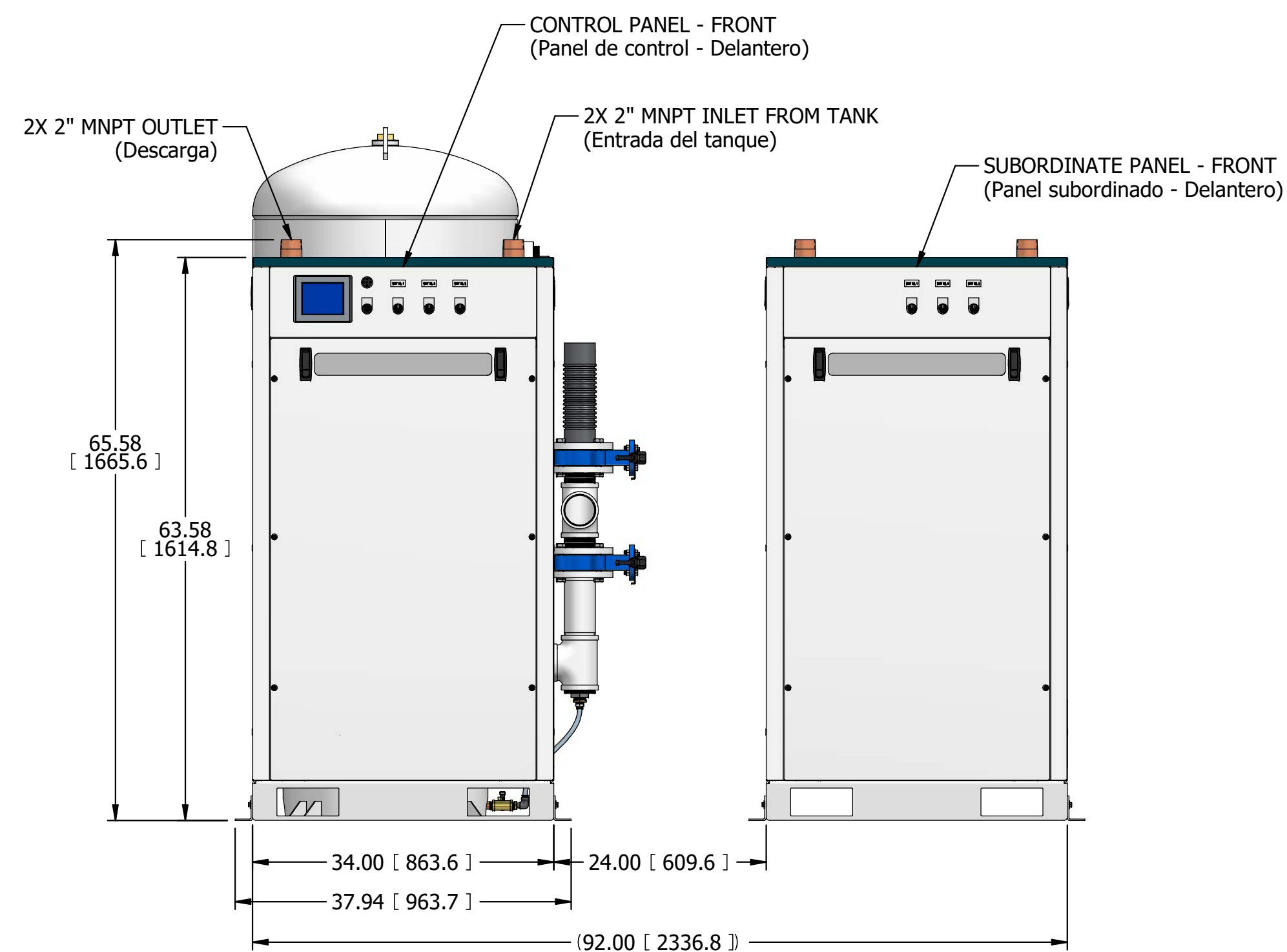
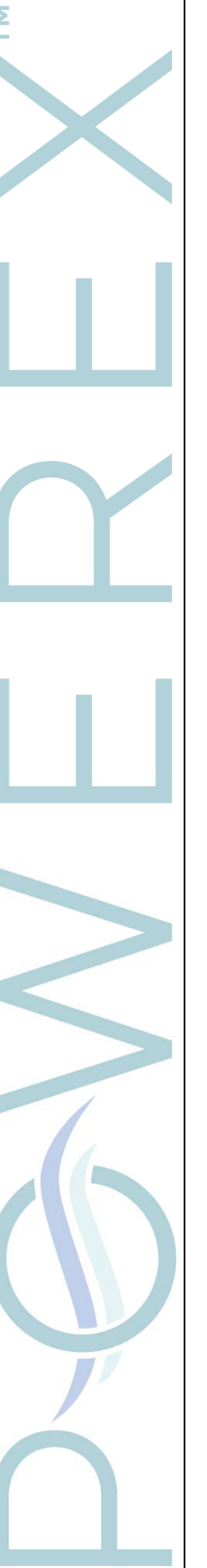

- NOTES:
- APPROXIMATE WEIGHT: 4391 LBS
 - A MINIMUM OF 24" CLEARANCE IS RECOMMENDED AROUND THE ENTIRE UNIT. CLEARANCE FOR CONTROL PANEL SHALL BE IN ACCORDANCE WITH OSHA/NEC REQUIREMENTS.
 - ALL PLUMBING FROM TANK OUTLET TO ENCLOSURE INLET(S) SHALL BE FIELD-SUPPLIED.
 - SYSTEM DESIGNED IN COMPLIANCE WITH U.S. NFPA '99, LATEST EDITION.
- PESO APROXIMADO: 1992 kg
 - RECOMENDAMOS QUE EL ESPACIO LIBRE ALREDEDOR DEL SISTEMA DEBE SER COMO MÍNIMO 24" (600 mm). EL ESPACIO LIBRE PARA EL TABLERO DE CONTROL DEBERÁ ESTAR DE ACUERDO CON LOS REQUERIMIENTOS DE SEGURIDAD DE LA OSHA/NEC.
 - TODA LA PLOMERÍA DESDE LA DESCARGA DEL TANQUE HASTA LA(S) ENTRADA(S) DEL CERCADO DEBE SER SUMINISTRADA POR EL CLIENTE.
 - EL SISTEMA ESTÁ DISEÑADO DE ACUERDO CON LA ÚLTIMA EDICIÓN DE LA NFPA 99.

SYMBOL LEGEND		DRAWINGS TO CONFORM TO CURRENT REVISION OF THE FOLLOWING ANSI STANDARDS:		
		Y14.3 MULTI AND SECTIONAL VIEW DWGS		
		Y14.5 DIMENSIONING AND TOLERANCING		
TOLERANCES, UNLESS OTHERWISE SPECIFIED	SOLID EDGE DRAWING	DO NOT SCALE DRAWING FOR DIMENSIONS		
0.XXX ± .005				
0.XXX ± .005				
± .1	INCH [mm]	SHEET 1 OF 2	SCALE	1:10
CONFIDENTIAL DISCLOSURE This drawing is the property of POWEREX of the SCOTT FEZTER COMPANY and is subject to return on demand. Its contents are confidential and must not be copied or submitted to outside parties for use or examination.		AUTHOR	REVISION DATE	APPROVALS ON FILE IN PLM
ITEM NO: 752179		rhuy	12/21/2023	
MATERIAL: ---		POWEREX 150 PRODUCTION DRIVE, HARRISON OH 45030 (888) 769-7979		
DESCRIPTION	DRAWING NUMBER	REVISION	SIZE	
MED VAC ENCLOSURE 4 HP QUADPLEX CLAW 200G TANK	MVECQ0405xx1	A	D	

MVECQ0405xx1

MED VAC ENCLOSURE 4 HP QUADPLEX CLAW 200G TANK

REVISION NOTES		
DESCRIPTION	ECN	PR/NOR
RELEASE TO PRODUCTION	PXEC0558	XXXXXXX

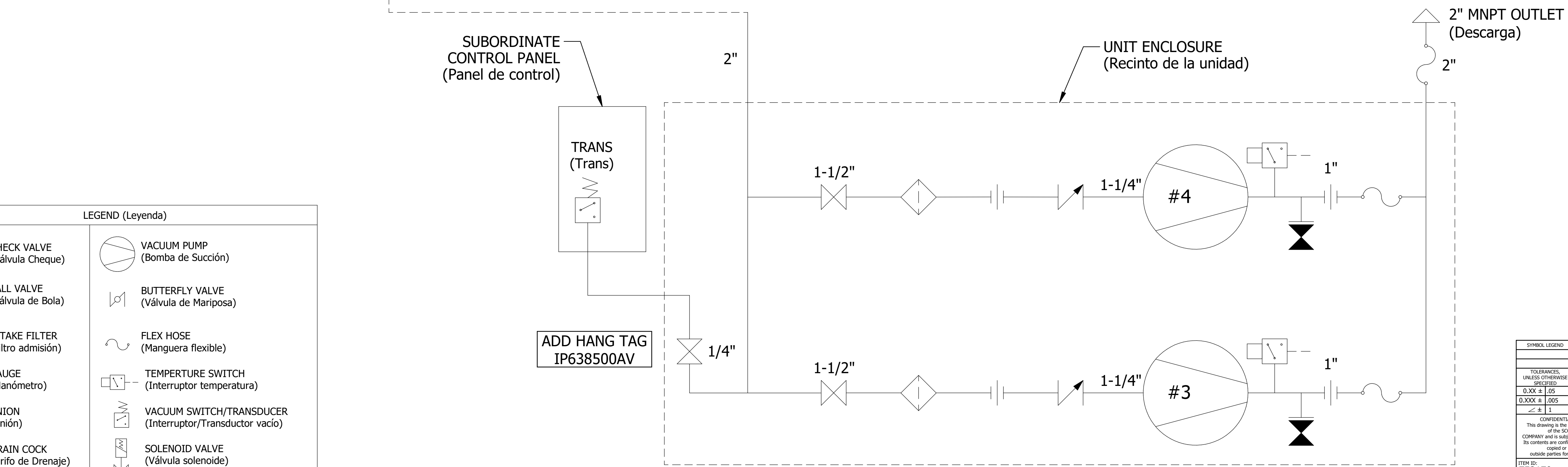
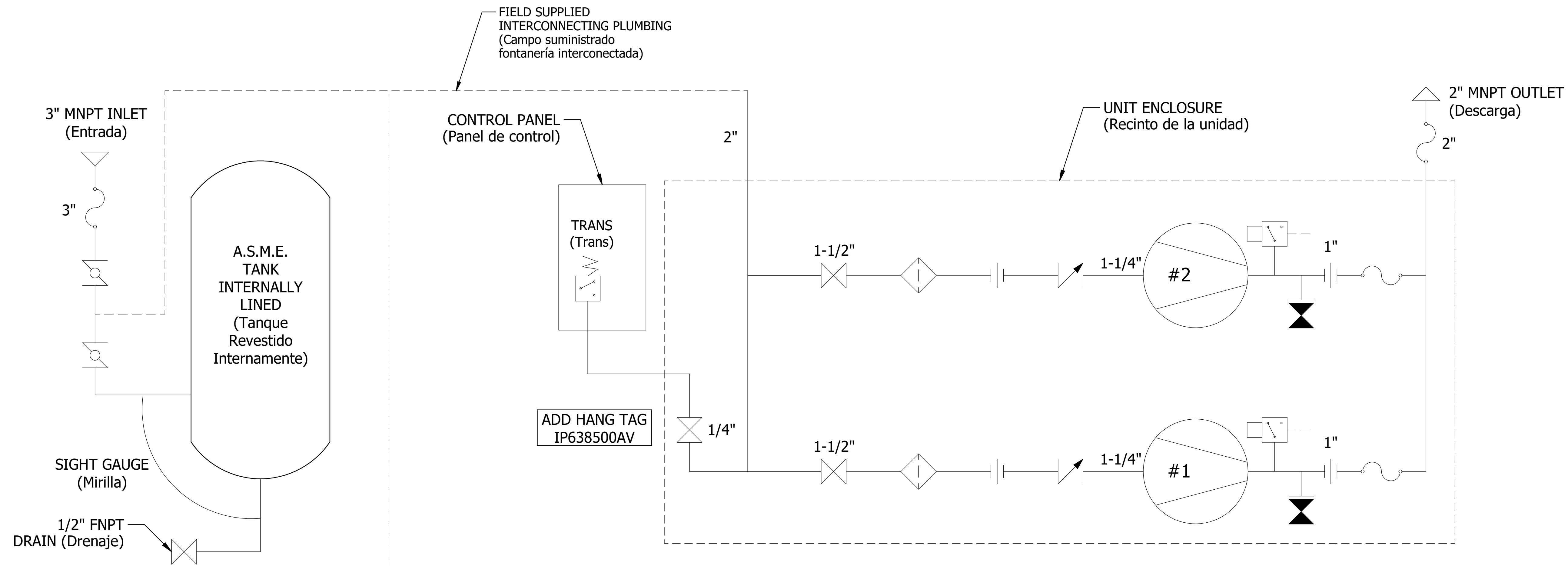
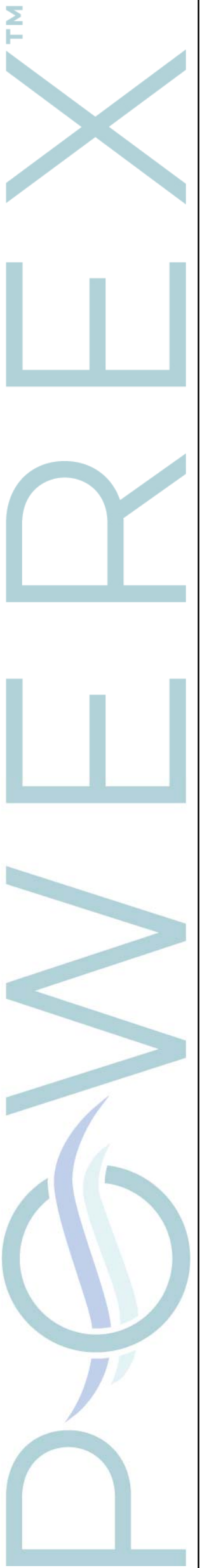

LEGEND (Leyenda)

	CHECK VALVE (Válvula Cheque)		VACUUM PUMP (Bomba de Succión)
	BALL VALVE (Válvula de Bola)		BUTTERFLY VALVE (Válvula de Mariposa)
	INTAKE FILTER (Filtro admisión)		FLEX HOSE (Manguera flexible)
	GAUGE (Manómetro)		TEMPERATURE SWITCH (Interruptor temperatura)
	UNION (Unión)		VACUUM SWITCH/TRANSDUCER (Interruptor/Transductor vacío)
	DRAIN COCK (Grifo de Drenaje)		SOLENOID VALVE (Válvula solenoide)
	AIR LINE (Tubería de Aire)		CONDENSATE LINE (Línea de Condensado)

SYMBOL LEGEND		DRAWINGS TO CONFORM TO CURRENT REVISION OF THE FOLLOWING STANDARDS:	
		Y14.3 MULTI AND SECTIONAL VIEW DWGS	
		Y14.5 DIMENSIONING AND TOLERANCING	
TOLERANCES, UNLESS OTHERWISE SPECIFIED:	SOLID EDGE DRAWING	DO NOT SCALE DRAWING FOR DIMENSIONS	
0.XXX ± .005			
0.XXX ± .005	INCH [mm]	SHEET 2 OF 2	SCALE 1:1
± .1			
CONFIDENTIAL DISCLOSURE		AUTHOR	REVISION DATE
This drawing is the property of POWEREX of the SCOTT FEZTER COMPANY and is subject to return on demand. Its contents are confidential and must not be copied or submitted to outside parties for use or examination.		rhuy	12/21/2023
APPROVALS ON FILE IN PLM			
ITEM NO: 752179		POWEREX	
MATERIAL: ---		150 PRODUCTION DRIVE, HARRISON OH 45030 (888) 769-7979	
DESCRIPTION: MED VAC ENCLOSURE 4 HP QUADPLEX CLAW 200G TANK		DRAWING NUMBER: MVECQ0405xx1	REVISION: A
		SIZE: A	D